

element • Roku TV

User Guide

Models: E4SC4018RKU

English



Illustrations in this guide are provided for reference only and may differ from actual product appearance.

Product design and specification may be changed without notice.

Safety instructions

WARNING:

TO REDUCE THE RISK OF ELECTRIC SHOCK DO NOT REMOVE COVER (OR BACK).
NO USER SERVICEABLE PARTS INSIDE. REFER TO QUALIFIED SERVICE PERSONNEL.



The lightning flash with arrowhead symbol, within an equilateral triangle, is intended to alert the user to the presence of uninsulated "dangerous voltage" within the products enclosure that may be of sufficient magnitude to constitute a risk of electric shock to persons.



The exclamation point within an equilateral triangle is intended to alert the user to the presence of important operating and maintenance (servicing) instructions in the literature accompanying the appliance.

IMPORTANT SAFETY INSTRUCTIONS

- 1) Read these instructions.
- 2) Keep these instructions.
- 3) Heed all warnings.
- 4) Follow all instructions.
- 5) Do not use this apparatus near water.
- 6) Clean only with dry cloth.
- 7) Do not block any ventilation openings. Install in accordance with the manufacturer's instructions.
- 8) Do not install near any heat sources such as radiators, heat registers, stoves, or other apparatus (including amplifiers) that produce heat.
- 9) Do not defeat the safety purpose of the polarized or grounding-type plug. A polarized plug has two blades with one wider than the other. A grounding type plug has two blades and a third grounding prong. The wide blade or the third prong are provided for your safety. If the provided plug does not fit into our outlet, consult an electrician for replacement of the obsolete outlet.
- 10) Protect the power cord from being walked on or pinched particularly at plugs, convenience receptacles, and the point where they exit from the apparatus.
- 11) Only use attachments/accessories specified by the manufacturer.
- 12) Use only with cart, stand, tripod, bracket, or table specified by the manufacturer, or sold with the apparatus. When a cart is used, use caution when moving the cart/apparatus combination to avoid injury from tip-over.
- 13) Unplug this apparatus during lightning storms or when unused for long periods of time.
- 14) Refer all servicing to qualified service personnel. Servicing is required when the apparatus has been damaged in any way, such as power-supply cord or plug is damaged, liquid has been spilled or objects have fallen into the apparatus, the apparatus has been exposed to rain or moisture, does not operate normally, or has been dropped.
- 15) To prevent the spread of fire, keep candles or other open flames away from this product at all times.
- 16) The ventilation should not be impeded by covering the ventilation openings with items, such



- as newspapers, tablecloths, curtains, etc
- 17) Apparatus should not be exposed to dripping or splashing, and objects filled with liquids, such as vases, should not be placed on the apparatus.
 - 18) When you install your TV, maintain a distance of at least 4 inches between the TV and other objects (walls, cabinet sides, etc.) to ensure proper ventilation. Failing to maintain proper ventilation may result in a fire or a problem with the product caused by an increase in its internal temperature.
 - 19) Attention should be drawn to the environmental aspects of battery disposal. Don't throw used batteries in dustbin.
 - 20) An outside antenna system should not be located in the vicinity of overhead power lines or other electric light or power circuits, or where it can fall into such power lines or circuits. When installing an outside antenna system, extreme care should be taken to keep from touching such power lines or circuits, as contact with them might be fatal.
 - 21) Do not overload wall outlets and extension cords, as this can result in a risk of fire or electric shock.
 - 22) Do not push objects through any openings in this unit, as they may touch dangerous voltage points or short out parts that could result in fire or electric shock. Never spill or spray any type of liquid into the unit.
 - 23) If an outside antenna or cable system is connected to the unit, be sure the antenna or cable system is grounded to provide some protection against voltage surges and built-up static charges, Section 810 of the National Electrical Code, ANSI/NFPA 70, provides information with respect to proper grounding of the mast and supporting structure, grounding of the lead-in wire to an antenna discharge unit, size of grounding conductors, location of antenna discharge unit, connection to grounding electrodes, and requirements for the grounding electrode.
 - 24) When replacement parts are required, be sure the service technician uses replacement parts specified by the manufacturer or those that have the same characteristics as the original part. Unauthorized substitutions may result in fire, electric shock or other hazards.
 - 25) Upon completion of any service or repairs to this unit, ask the service technician to perform safety checks to determine that the unit is in proper operating condition.
 - 26) When you connect the product to other equipment, turn off the power and unplug all of the equipment from the wall outlet. Failure to do so may cause an electric shock and serious personal injury. Read the owner's manual of the other equipment carefully and follow the instructions when making any connections.
 - 27) Do not allow the product to output distorted sound for an extended period of time. It may cause speaker overheating and fire.
 - 28) This reminder is provided to call the cable TV system installer's attention to Article 820-40 of the NEC that provides guidelines for proper grounding and, in particular, specifies that the cable ground shall be connected to the grounding system of the building, as close to the point of cable entry as practical.
 - 29) Sudden high volume sound may cause hearing or speaker damage. When you use headphones, (if the unit is equipped with a headphone jack) keep the volume at a moderate level. If you use headphones continuously with high volume sound, it may cause hearing damage.
 - 30) The mains plug is used as the disconnect and shall remain readily operable.
 - 31) The batteries (battery pack or batteries installed) shall not be exposed to excessive heat such as sunshine, fire or the like.
 - 32)  This equipment is a Class II or double insulated electrical appliance. It has been designed in such a way that it does not require a safety connection to electrical earth.

33) The use of apparatus in moderate climates.

Operating Temperature: 0°C to 35°C Operating Humidity: ≤80%

Storage Temperature: 0°C to 50°C Storage Humidity: ≤90%

HOW TO HANDLE THE LCD PANEL

- Do not press hard or jolt the LCD panel. It may cause the LCD panel glass to break and injury may occur.
- If the LCD panel is broken, make absolutely sure that you do not touch the liquid in the panel. This may cause skin inflammation.

If the liquid gets in your mouth, immediately gargle and consult with your doctor. Also, if the liquid gets in your eyes or touches your skin, consult with your doctor after rinsing for at least 15 minutes or longer in clean water.

Possible Adverse Effects on LCD Panel: If a fixed (non-moving) pattern remains on the LCD Panel for long periods of time, the image can become permanently engrained in the LCD Panel and cause subtle but permanent ghost images. This type of damage is NOT COVERED BY YOUR WARRANTY. Never leave your LCD Panel on for long periods of time while it is displaying the following formats or images:

- Fixed Images, such as stock tickers, video game patterns, TV station logos, and websites.
- Special Formats that do not use the entire screen. For example, viewing letterbox style (16:9) media on a normal (4:3) display (black bars at top and bottom of screen); or viewing normal style (4:3) media on a widescreen (16:9) display (black bars on left and right sides of screen).

The following symptoms are not signs of malfunction but technical limitation. Therefore we disclaim any responsibility for these symptoms.

- LCD Panels are manufactured using an extremely high level of precision technology, however sometimes parts of the screen may be missing picture elements or have luminous spots.
- Do not install the LCD Panel near electronic equipment that produces electromagnetic waves. Some equipment placed too near this unit may cause interference.
- Effect on infrared devices – There may be interference while using infrared devices such as infrared cordless headphones.

Power source

This television is designed to operate on 120 volts 60 Hz, AC current. Insert the power cord into a 120 volts 60 Hz outlet.

To prevent electric shock, do not use the television's (AC) plug with an extension cord, receptacle, or other outlet unless the blades can be fully inserted to prevent blade exposure.

Never connect the television to 50 Hz, direct current, or anything other than the specified voltage.

Warning

To reduce the risk of fire or electric shock, do not expose this apparatus to rain or moisture.

Caution

Never remove the back cover of the television as this can expose you to very high voltages and other hazards. If the television does not operate properly, unplug the television and call your authorized dealer or service center. Adjust only those controls that are covered in the instructions, as improper changes or modifications not expressly approved by Element could void the user's warranty.

FCC Statement

Declaration of Conformity

This device complies with part 15 of the FCC Rules. Operation is subject to the following two conditions: (1) This device may not cause harmful interference and (2) This device must accept any interference received, including interference that may cause undesired operation.

Note: This equipment has been tested and found to comply with the limits for a class B digital Device, pursuant to part 15 of the FCC Rules. These limits are designed to provide reasonable protection against harmful interference in a residential installation. This equipment generates, uses and can radiate radio frequency energy and, if not installed and used in accordance with the instructions, may cause harmful interference to radio Communications. However, there is no guarantee that interference will not occur in a particular installation. If this equipment does cause harmful interference to radio or television reception, which can be determined by turning the equipment off and on, the user is encouraged to try to correct the interference by one or more of the following measures:

- Reorient or relocate the receiving antenna.
- Increase the separation between the equipment and the receiver.
- Connect the equipment into an outlet on a circuit different from that to which the receiver is connected.
- Consult the dealer or an experienced radio/TV technician for help.

NOTE: The manufacturer is not responsible for any radio or TV interference caused by unauthorized modifications to this equipment. Such modifications could void the user's authority to operate the equipment.

FCC Radiation Exposure Statement

This equipment complies with FCC radiation exposure limits set forth for an uncontrolled environment. This equipment should be installed and operated with minimum distance 20cm between the radiator & your body.

For customer support: (888) 842-3577

Please send all correspondence to:

Element TV Company, LP. Customer Service

customerservice@elementelectronics.com

www.elementelectronics.com

Attach the TV stand or wall mount bracket (not included)

Attach the TV Stand

CAUTION:

- Be sure to disconnect the AC power cord before installing a stand or wall mount brackets.
- The LED display is very fragile and must be protected at all times when installing the legs that form the stand. Be sure to protect the TV screen from getting scratched or damaged by any hard objects. In addition, DO NOT exert pressure on the front of the TV at any time because it could crack.

To attach the left and right legs that forms the stand:

1. Carefully place your TV face down on a soft, flat surface to prevent damage to the TV or scratching to the screen.

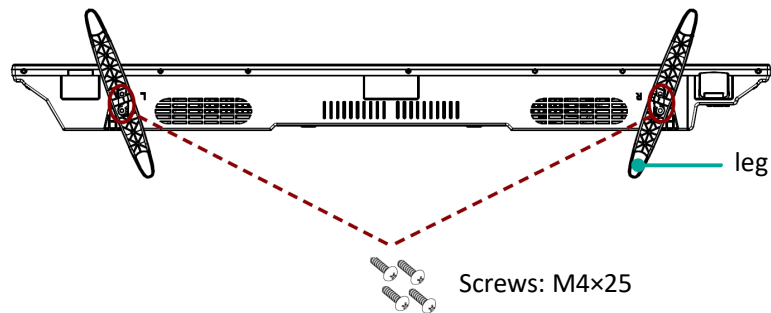

2. Place the legs into the bottom slots of the TV, insert and tighten the screws (found in the accessories bag) in the circled area with the screwdriver (not provided).
3. Then the TV is ready for use.



NOTE: Be sure to follow the above instructions. Insufficient tightening or incorrect installation of the stand will not support your TV correctly, and could result in damage or injury from tip-over.

Attach the Wall Mount Bracket (not included)

Before you begin the third-party manufacturer instructions, be sure to do the following things:

1. Place the TV face down on a clean, safe and cushioned surface.
2. Remove the TV stand if you already attached it.
3. Place the spacers (not included) in the corresponding bracket holes.

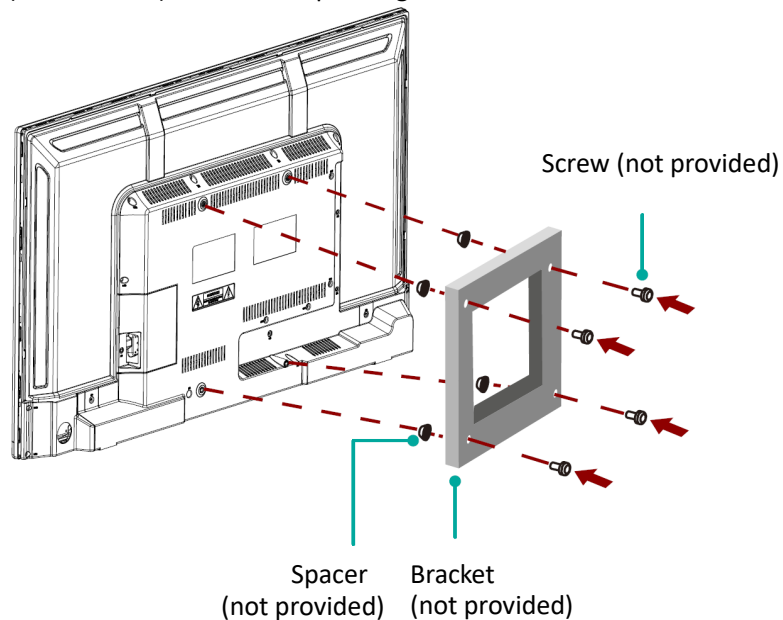

CAUTION:

- When you attach the mount, be sure to use the spacers (provided by the third-party manufacturer) between the TV and the bracket.
- To prevent internal damage to the TV and ensure it is mounted securely, be sure to use fixing screws (not provided) that are 10 mm in length when measured from the attaching surface of the mounting hook.

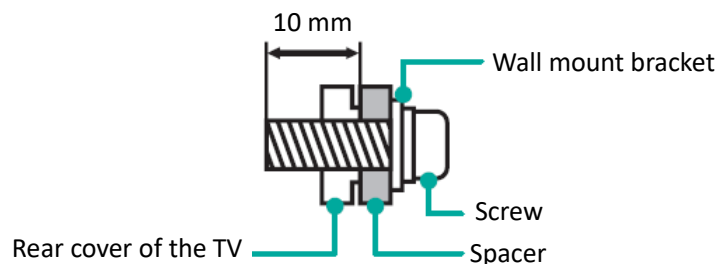

Wall mount hole pattern VESA (mm)	200 × 300
Wall mount screw size (mm)	M6

Follow instructions provided with the wall mount bracket.

- To complete the installation, please contact the wall mount manufacturer or the retailer from which you purchased the TV.
- The selected screws are 10 mm in length when measured from the attaching surface of the rear cover. The diameter and length of the screws differ depending on the wall mount bracket model.



NOTE: The diameter and length of the screws differ depending on the wall mount bracket model.

Connect your TV

Connecting an antenna, cable, or satellite box

If you are using an antenna, CATV cable without a set-top box, or a cable or satellite box that has only an antenna output, connect a 75-ohm coaxial cable (not provided) from the device to the ANT/CABLE input on the TV.

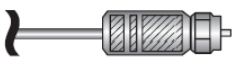
Tip: If you are using an antenna with a 300 ohm twin-lead cable, you need to use a 300-75 ohm adapter (not provided) to adapt the cable to a connection that is compatible with the TV's antenna input.

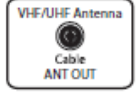
TV label	Port	Cable	External Equipment
RF(75Ω)			 Antenna  RF Out

Tip: If you receive your TV stations through a set top box from a cable or satellite TV provider, connect it to the TV using the best connection method available. From most to least desirable:









- **HDMI® input** – Digital HD and SD video
- **AV input** – analog SD video
- **Antenna input** – analog SD video using NTSC

Connecting a component with a composite AV video cable

If the best connection available on your component is AV or composite video output, connect it to the TV using a composite AV cable (not provided). Composite AV cables typically have three Element-type plugs on each end, color coded as follows:

- **Yellow:** Video
- **Red:** Audio, right channel
- **White or black:** Audio, left channel

Connect each plug to the corresponding connector on the component and on the TV.

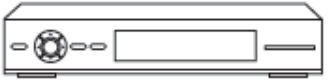



TV label	Port	Cable	External Equipment
AV IN		 Yellow	 VCR
		 White	 DVD Player/Recorder
		 Red	 Set-top Box

Connecting a component with an HDMI® cable

If possible, connect your devices using HDMI® cables (not provided). They help to provide the best video quality and also carry audio signals, so that only one cable is needed. For better picture quality, we recommend that you use cables designated as High Speed HDMI® cables.

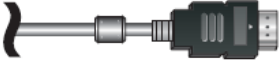
Tip: You might need to configure the component to send its signal through its HDMI® connector.

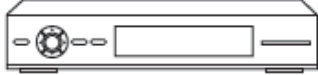
The connector labeled **HDMI (ARC)** has the additional ability to use the audio return channel to send digital audio to a receiver or sound bar.

TV label	Port	Cable	External Equipment
HDMI IN			 VCR  DVD Player/Recorder  Set-top Box  Satellite Receiver Satellite antenna cable



Connecting headphones or analog sound bar

You can connect headphones or an analog sound bar (not provided) to the TV's headphone jack.

Tip: Inserting a plug in the headphone jack disables the sound from the TV's built-in speakers.

[[Partner-specific illustration showing headphone connection]]

Warning: Loud noise can damage your hearing. When using headphones, use the lowest volume setting on your headphones that still lets you hear the sound.







TV label	Port	Cable	External Equipment
Headphones 			

Connecting an AV receiver or digital sound bar

You can enjoy Dolby Digital multichannel sound from your TV if you connect a digital amplifier or sound bar (not provided) in either of two ways:

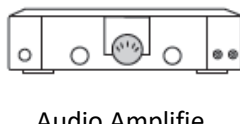
- **OPTICAL (Digital audio out)** –Connect an optical cable (not provided) from an external digital audio system.

- HDMI® ARC** – Connect an HDMI® cable (not provided) from the HDMI (ARC) connector to the HDMI® input on your receiver or sound bar. This connection uses the Audio Return Channel (ARC) feature of the HDMI® specification to output sound from the TV to a compatible device. To use this feature, you must configure the TV to enable HDMI® ARC.

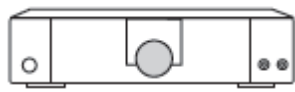
<i>TV label</i>	<i>Port</i>	<i>Cable</i>	<i>External Equipment</i>
OPTICAL			 Audio Amplifier  Speaker
HDMI /ARC			 Digital Sound Bar

Preparing for Internet connectivity

Connecting to a Wired (Ethernet) Network

Connect your TV to your network by connecting the LAN port on the back of your TV to an external modem or router using a LAN (Ethernet/Cat 5) cable. See the illustration below.

We recommend to use a modem or router that supports Dynamic Host Configuration Protocol (DHCP). Modems and routers that support DHCP automatically provide the IP address, subnet mask, gateway, and DNS, so you don't have to enter them manually. Most home networks already have DHCP.

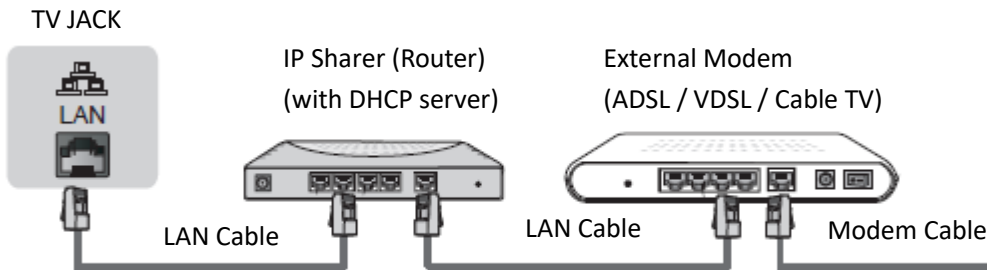

Connecting to a Wireless Network

If you want to watch streaming content and take advantage of the cool features of your Roku TV, connect it to the Internet through a wireless modem/router or a wireless access point (not provided). The TV has a built-in wireless LAN adapter.

Connect your TV to your network wirelessly, you need a wireless router or modem. See the illustration below.

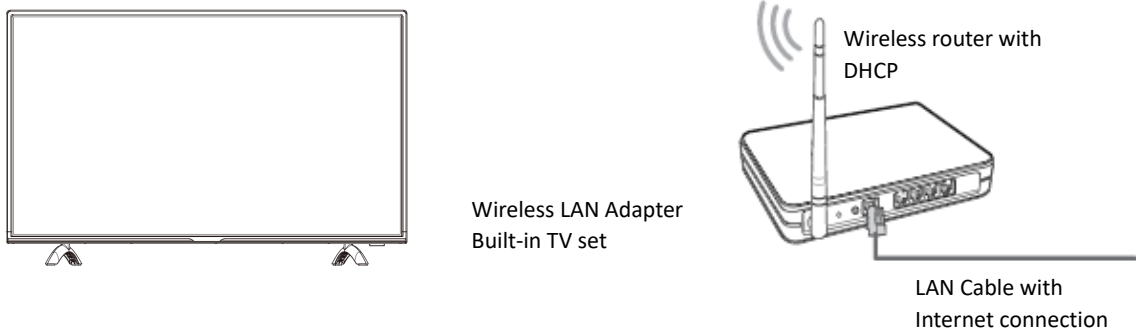

NOTES:

- For the best viewing experience, we recommend using a wireless router or access point that supports the following wireless networking standards, depending on your TV model:
- If the wireless router supports DHCP, your TV can connect more easily to the wireless network.
- If you apply a security system other than the systems listed below, it will not work with the TV.

Security system: WPA, WEP, WPA2.

- In order to guarantee smooth streaming video playback, the distance between router and TV should be less than 10 meters.

AC power

Plug your TV into a power outlet. You can tell that the TV has power because the status light on the front of the TV lights up.

Remote control batteries

Open the back of your Roku TV remote control and insert the included batteries as indicated in the label in the battery compartment. Reattach the back cover.

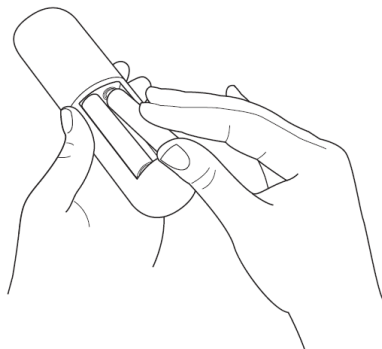

Roku TV™ User Guide

Detailed instructions on using your Element Roku TV are available in the Roku TV User Guide that is available as a PDF file. To obtain your copy of the user guide:

1. From your computer or mobile device, go to go.roku.com/TVmanual. The page, “How to set up your Roku TV™” opens.
2. Click the **Roku TV User Guide** link in this article to download the user guide.
3. If the user guide does not open automatically after the download completes, go to your browser’s download location and open **Roku-TV-User-Guide-*n-n*.pdf**. (*n-n* represents the current version number of the Roku TV software described in the user guide.)

FAQ

When you experience an issue with your TV, turn it off and unplug it, wait 30 seconds, and then reconnect the AC power. If this does not resolve the problem, then refer to the tips below. If the problem is still not resolved, then contact Manufacturer Customer Care.

PROBLEM	POSSIBLE SOLUTIONS
You do not see a picture when turning on the TV	<ul style="list-style-type: none"> • If the TV is Off, check that the status LED is On. If the TV is On, press any button on the remote control to make sure it is not in power saver mode. • The TV may be in Standby mode. Press the Power button on the remote control to activate the unit from Standby. • Check if the power cord is plugged into an active electrical outlet.
You have connected an external source to your TV but cannot find it on the Home screen	<ul style="list-style-type: none"> • Make sure your external source is turned on. • Check to see if the correct input tile is selected on the Home Screen for the external source you want to view. • Make sure you have not removed the input from your Home screen. To add it back, select Settings > TV Inputs. • Check to see if the external source device connection is snug and fully inserted into the TV port.
When you turn on your TV, there is a delay for a few seconds before the picture appears	<ul style="list-style-type: none"> • This is normal. If you have already set up your TV, it is initializing and restoring previous setting information.
You see a normal picture but do not hear any sound	<ul style="list-style-type: none"> • Check that volume is turned up. • Check if "Mute" mode is ON. Turn off mute by pressing the Mute button again, or pressing volume up. • Make sure TV speakers are enabled. To enable them, go to Settings > Audio > TV Speakers.
You hear sound but picture color is faded or in black and white	<ul style="list-style-type: none"> • Check that the Color value is set to 50 or greater. • Check the color on another channel or input tile.
Your sound or picture is distorted or appears wavy	<ul style="list-style-type: none"> • Turn off and/or remove any electrical appliance that may be nearby the TV panel. • Insert the power plug of the TV set into another power outlet.
Your sound or picture is blurry or cuts out	<ul style="list-style-type: none"> • If you are using an external antenna, check the connections for a snug and tight fit. • Adjust or reposition the antenna placement. • You are too far from the TV station to receive a satisfactory signal. Consider hiding the channel by going to Settings > TV inputs > Antenna TV > Edit channel lineup.
You see horizontal/vertical stripes on the picture, or it is shaking	<ul style="list-style-type: none"> • Turn off and/or remove any electrical appliance that may be nearby the TV panel. • Insert the TV power cord into another electrical outlet.
You cannot connect to your wireless network	<ul style="list-style-type: none"> • Make sure you have selected the correct wireless network name on the Choose Wireless Network screen. • Make sure that you entered the correct wireless password for your network (passwords are case sensitive). • If you have turned off SSID broadcasting on your wireless router, add your network by selecting Add Private Network from the Select Wireless Network screen.

	<ul style="list-style-type: none"> • To check if it is a password problem, temporarily disable security on the wireless router. • If you are not getting 3 or more signal strength bars above the wireless network icon, adjust the position of the TV (if possible) or the wireless router. Even a few inches in one direction or another may help.
Your remote control is not responding to button presses	<ul style="list-style-type: none"> • Check that the TV is still on. • Check that the batteries are good and are inserted properly. • Check that there are no obstacles between the remote control and the front of the TV. • Try moving closer to the TV. If the LED on the TV flashes when you press any of the buttons on the remote control, the issue is not with the remote control. • If all of these measures fail, try unplugging the TV, waiting 30 seconds, and then reconnecting AC power.

For the latest answers to Frequently Asked Questions, visit the Roku support website (www.roku.com/support).

Specifications

Panel Size	40 inches diagonally
Display Type	LED
Panel Technology	TFT
TV System	ATSC/NTSC-M
Channel Range	VHF: 2~13
Channel Range	UHF: 14~69
Channel Range	CATV: 1~135
Tuner Type	Frequency synthesized
Display Resolution	Up to 4K
Panel Resolution	3840 x 2160
Aspect Ratio	16:9
Contrast Ratio-Panel	4000:1(Typ.)
Response Time (G To G)	8 ms
Lamp Life (Typ. Hours)	30,000 hours
Horizontal Viewing Angle (At CR≥10)	170
Vertical Viewing Angle (At CR≥10)	170
Power Supply	AC 120V ~ 60Hz
Ports	3 HDMI ports, 2 USB ports, 1 LAN port for Ethernet, 1 Optical Output, 1 RF Input, 1 Earphone Audio Output, Element Composite Video Input, 1 left/right Audio Input for Composite
Other features	Smart TV, Dynamic contrast picture, VESA standard wall mount support

Disclaimer: All product, product specifications, and data are subject to change without notice to improve reliability, function, design or otherwise.

Dolby Digital

Manufactured under license from Dolby Laboratories.
Dolby, Dolby Audio, and the double-D symbol are trademarks of Dolby Laboratories.



HDMI®

The terms HDMI® and HDMI® High-Definition Multimedia Interface, and the HDMI® Logo are trademarks or registered trademarks of HDMI® Licensing LLC in the United States and other countries.



Roku

ROKU, ROKU TV and the ROKU logo are the trademarks or registered trademarks of Roku, Inc. All other trademarks and logos herein are the property of their respective owners.

