



User Manual

18.7 cu.ft. Bottom Freezer Refrigerator

ERBM19CBS ERBM19CBW ERBM19CBB

Product may vary. Please refer to the actual product.

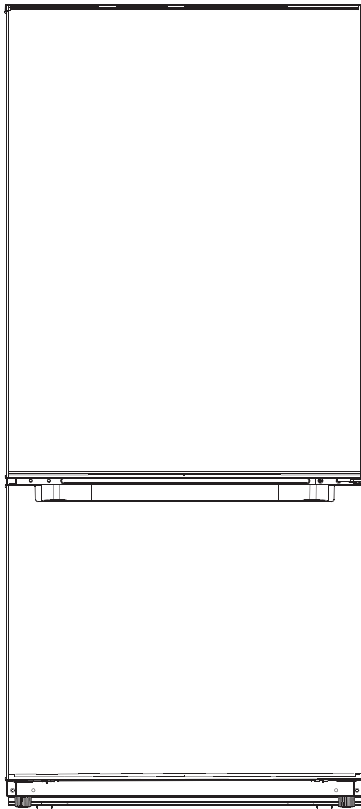

Before using your new product, please read these instructions to prevent any damage.

CONTENTS

1 Safety Warnings	
1.1Warning	1-2
1.2Meanings of safety warning symbols	3
1.3Electricity related warnings	3
1.4Warnings for using	4
1.5Warnings for placement	4-5
1.6Warnings for energy	5
1.7Warnings for disposal	5
2 Proper Use of the Refrigerator	
2.1Placement	6
2.2Leveling feet	7
2.3Leveling door	8-10
2.4Changing the light	10
2.5Starting to use	10
2.6Energy saving tips	10
3 Structure and Functions	
3.1Key components	11
3.2Functions	12-13
4 Maintenance and Care of the Refrigerator	
4.1Overall cleaning	14
4.2Cleaning of door tray	14
4.3Glass shelf cleaning	15
4.4Box gill bottom roller groove cleaning	15
4.5Defrosting	16
4.6Out of operation	16
5 Troubleshooting	
5.1Troubleshooting	17
6 Warranty	
6.1Warranty	18-20

1 Safety Warnings

1.1 WARNING



Warning: risk of fire / flammable materials

This appliance is intended to be used in household and similar locations such as staff kitchen areas in shops, offices and other working environments, farmhouses and by clients in hotels, motels and other residential type environments, bed and breakfast type environments, catering and similar non-retail locations.

This appliance is not intended for use by people (including children) with reduced physical, sensory, intellectual capabilities, or lack of experience and knowledge, unless they have been given supervision or instruction concerning use of the appliance by a person responsible for their safety.

Children should be supervised to ensure that they do not play with the appliance.

If the supply cord is damaged, it must be replaced by the manufacturer, its service agent or similarly qualified persons in order to avoid a hazard.

Do not store explosive substances such as aerosol cans with a flammable propellant in this appliance.

The appliance has to be unplugged after use and before carrying out user maintenance on the appliance.

WARNING: Keep ventilation openings, in the appliance enclosure or in the built-in structure, clear of obstruction.

WARNING: Do not use mechanical devices or other means to accelerate the defrosting process, other than those recommended by the manufacturer.

WARNING: Do not damage the refrigerant circuit.

WARNING: Do not use electrical appliances inside the food storage compartments of the appliance, unless they are of the type recommended by the manufacturer.

WARNING: Properly dispose of the refrigerator according to local laws and regulations pertaining to flammable gases and refrigerants.

WARNING: When positioning the appliance, ensure the supply cord is not trapped or damaged.

WARNING: Do not locate multiple portable socket-outlets or portable power supplies at the rear of the appliance.

WARNING: Risk of child entrapment. Before you throw away your old refrigerator:

-Take off the doors.

-Leave the shelves in place so that children may not easily climb inside.

WARNING: To avoid a hazard due to instability of the appliance, it must be fixed in accordance with the instructions.





WARNING: Connect to potable water supply only. (Suitable for ice making machine)

Do not use extension cords or ungrounded (two prong) adapters.

The refrigerator must be disconnected from the source of electrical supply before attempting the installation of accessory.

Children should be supervised to ensure that they do not play with the appliance.

The instructions should include the substance of the following: To avoid contamination of food, follow the instructions:

- Opening the door for long periods can cause a significant increase of the temperature in the compartments of the appliance.
- Clean surfaces regularly that can come in contact with food and accessible drainage systems.
- Clean water tanks if they have not been used for 48h. Flush the water system connected to a water supply if water has not been drawn for 5 days. (note 1)
- Store raw meat and fish in suitable containers in the refrigerator, so that it is not in contact with or drip onto other food
- Two-star  frozen-food compartments are suitable for storing pre-frozen food, storing or making ice-cream and making ice cubes. (note 2)
- One , two  -and three-star  compartments are not suitable for the freezing of fresh food. (note 3)
- If the refrigerating appliance is left empty for long periods, switch off, defrost, clean, dry, and leave the door open to prevent mold developing within the appliance.

Note 1, 2, 3: Confirm whether it is applicable according to you product compartment type

Refrigerant and cyclopentane foaming material used for the appliance are flammable.

Therefore, when the appliance is scrapped, it should be kept away from any fire source and be recycled by a special recycling company with corresponding qualification other than be disposed by combustion, so as to prevent damage to the environment or any other harm.



For door or lids fitted with locks and keys, keep the keys out of the reach of children and not in the vicinity of the refrigerating appliance, in order to prevent children from being locked inside .

To prevent a child from being entrapped, keep out of reach of children and not in the vicinity of the freezer (or refrigerator). (Suitable for products with locks).

For employed with optional ice maker kit:

1. Minimum/Maximum inlet water pressure, 138/827 kPa (20/120 psig).
2. WARNING: Connect to potable water supply only.

1.2 Meaning of safety warning symbols

	This is a prohibition symbol. Any in compliance with instructions marked with this symbol may result in damage to the product or endanger the personal safety of the user.
	This is a warning symbol. It is required to operate in strict observance of instructions marked with this symbol; or otherwise damage to the product or personal injury may be caused.
	This is a cautioning symbol. Instructions marked with this symbol require special caution. Insufficient caution may result in slight or moderate injury, or damage to the product.

This manual contains a lot of important safety information which should be observed by the users.

1.3 Electricity related warnings

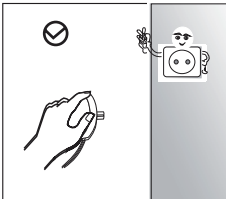

- Do not pull the power cord when pulling the power plug of the refrigerator. Firmly grasp the plug and pull it directly out of the socket.
- To ensure safe use, do not damage the power cord or use the power cord when it is damaged or worn.

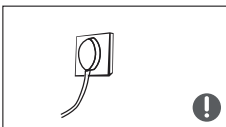

- Use a dedicated power socket. Make sure the power socket is not being shared with other electrical appliances.
- The power cord should be firmly contacted with the socket or else fires might be caused.
- Ensure that the grounding electrode of the power socket is equipped



- Turn off the valve of the leaking gas and then open the doors and windows in case of leakage of gas and other flammable gases.
- Do not unplug the refrigerator and other electrical appliances considering that spark may cause a fire.

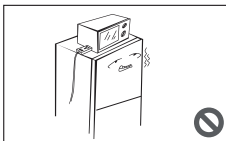

- Do not use electrical appliances on the top of the appliance, unless they are of the type recommended by the manufacturer.

1.4 Warnings for using

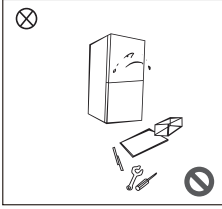

- Do not arbitrarily disassemble or reconstruct the refrigerator, or damage the refrigerant circuit. Maintenance of the appliance must be conducted by a specialist
- Damaged power cord must be replaced by the manufacturer, its maintenance department or related professionals in order to avoid danger.

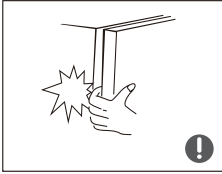

- The gaps between refrigerator doors and between doors and refrigerator body are small. Do not put your hand in these areas to prevent from squeezing the finger. Be considerate when closing the refrigerator door to avoid falling articles.
- Do not pick foods or containers with wet hands in the freezing chamber when the refrigerator is running, especially metal containers in order to avoid frostbite.



- Do not allow children to get into or climb the refrigerator; otherwise suffocation or injury of the child may be caused.

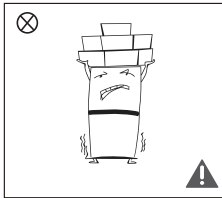

- Do not place heavy objects on top of the refrigerator considering that objectives may fall when opening or closing the door, and accidental injuries might be caused.

1.5 Warnings for placement

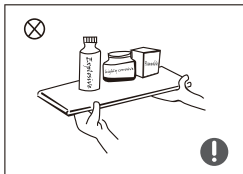

- Do not put flammable, explosive, volatile and highly corrosive items in the refrigerator to prevent damages to the product or fire accidents.
- Do not place flammable items near the refrigerator to avoid fires.

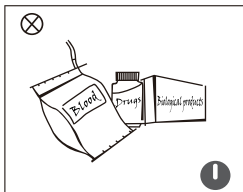

- The refrigerator is intended for household use, such as storage of foods. It should not be used for other purposes, such as storage of blood, drugs or biological products, etc.

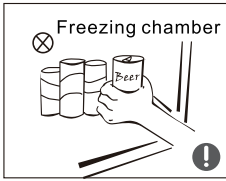

- Do not store beer, beverage or other fluids contained in bottles or enclosed containers in the freezing chamber of the refrigerator; otherwise the bottles or enclosed containers may crack due to freezing to cause damages.

1.6 Warning for energy

Warning for energy

- 1) Refrigerating appliances might not operate consistently (possibility of defrosting of contents or temperature becoming too warm in the frozen food compartment) when sited for an extended period of time below the cold end of the range of temperatures for which the refrigerating appliance is designed.
- 2) Effervescent drinks should not be stored in food freezer compartments or cabinets or in low-temperature compartments or cabinets, and that some products such as ice cubes should not be consumed too cold.
- 3) Do not exceed the storage time(s) recommended by the food manufacturers for any kind of food and particularly for commercially quick-frozen food in food-freezer and frozen-food storage compartments cabinets.
- 4) Take the necessary precautions to prevent an undue rise in the temperature of the frozen food while defrosting the refrigerating appliance, such as wrapping the frozen food in several layers of newspaper.
- 5) A rise in temperature of the frozen food during manual defrosting, maintenance or cleaning could shorten the storage life.

1.7 Warnings for disposal

Refrigerant and cyclopentane foaming material used for the refrigerator are flammable. Therefore, when the refrigerator is scrapped, it should be kept away from any fire source and be recycled by a special recycling company with corresponding qualification other than be disposed by combustion, so as to prevent damage to the environment or any other harm.



When the refrigerator is scrapped, disassemble the doors, and remove gasket of door and shelves. Put the doors and shelves in a proper place, so as to prevent trapping of any child.



Correct Disposal of this product:

This marking indicates that this product should not be disposed with other household wastes throughout the EU. To prevent possible harm to the environment or human health from uncontrolled waste disposal, recycle it responsibly to promote the sustainable reuse of material resources. To return your used device, use the return and collection systems or contact the retailer where the product was purchased. They can take this product for environmental safe recycling.

2 Proper Use of the Refrigerator

2.1 Placement

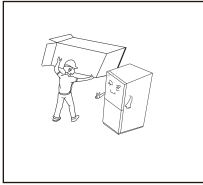

- Before use, remove all packing materials, including bottom cushions, foam pads and tapes inside the refrigerator.
- Tear off the protective film on the doors and the refrigerator body.

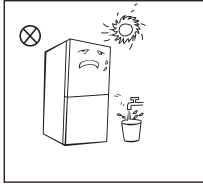

- Keep away from heat and avoid direct sunlight. Do not place the refrigerator in moist or watery places to prevent rust or reduction of insulating effect.
- Do not spray or wash the refrigerator. Do not put the refrigerator in moist places easy to be splashed with water so as not to affect the electrical insulation properties of the refrigerator.

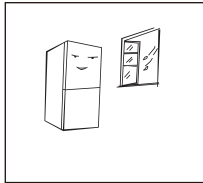

- The refrigerator should be placed in a well-ventilated indoor place; the ground should be flat, and sturdy (rotate left or right to adjust the wheel for leveling if unstable).

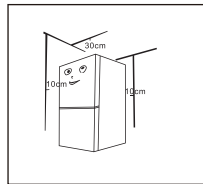

- This refrigerator needs to be installed independently and cannot be used as a built-in. Otherwise, it will cause problems such as failure to install into the cabinet, the performance and life of the product are reduced. The manufacturer does not provide basic product warranty.
- The top space of the refrigerator should be greater than 30cm, and the refrigerator should be placed against a wall with a free distance more than 10cm to facilitate heat dissipation.

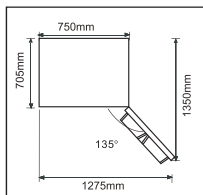

- Spare enough space for convenient opening of the doors and drawers.

The picture above is only for reference. The actual configuration will depend on the physical product or statement by the distributor.

2.2 Leveling feet

Schematic diagram of the leveling feet

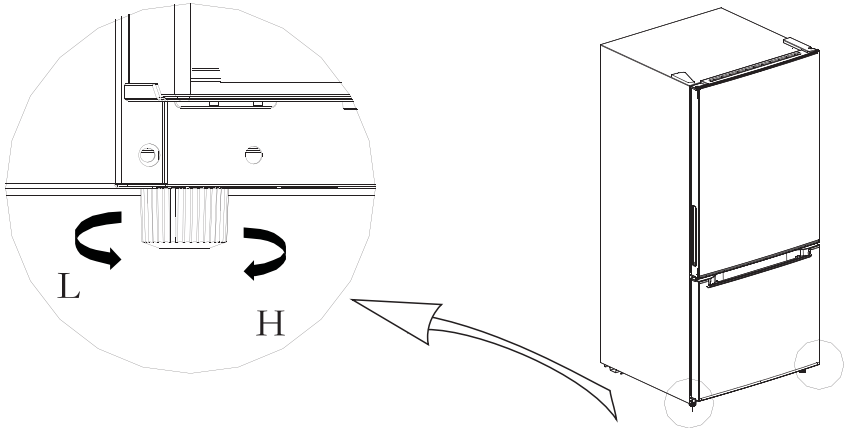





(The picture above is only for reference. The actual configuration will depend on the physical product or statement by the distributor)

Adjusting procedures:

- a. Turn the feet clockwise to raise the refrigerator.
- b. Turn the feet counterclockwise to lower the refrigerator.
- c. Adjust the right and left feet based on the procedures above to a horizontal level.

2. 3 Door right-left change

List of tools to be provided by the user			
	Cross screwdriver		Putty knife thin-blade screwdriver
	5/16" socket and ratchet		Masking tape

- 1) Unplug your refrigerator and remove all food from the door shelves. Remove all food from the inner door liner. Fix the door by tape.

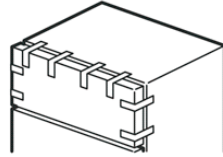

- 2) Remove the left cover plate and the right top hinge cover, then unscrew screws and remove the right top hinge. Keep the screws to reuse.

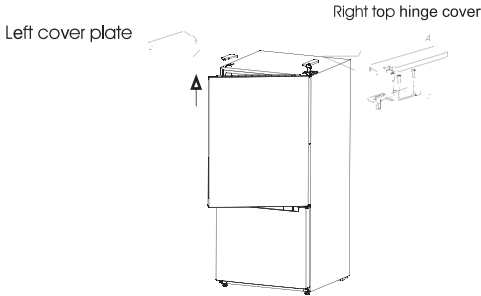

- 3) Lift the refrigerator door up and away from your refrigerator.

- 4) Dismantle the sleeves from the top right of doors and hole cap from top left of doors, and assemble them on the other side.

- 5) Remove the refrigerator door stopper and self-locking block on the right, take out the left self-locking block and stopper from the accessory bag in the refrigerator and installed on the left of door.

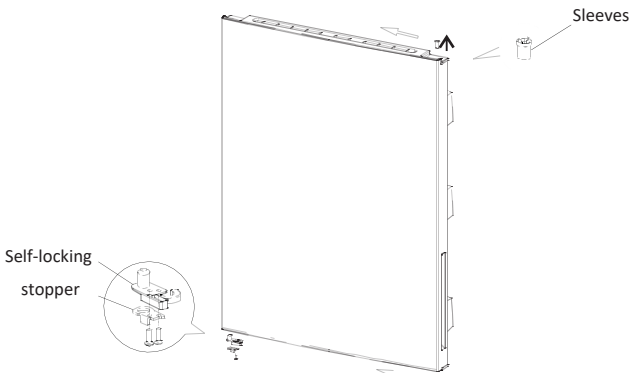

6) Remove the center hinge, then remove the center hinge shaft with a slotted screwdriver. Install the hinge shaft on opposite side of the hinge and install the hinge to the left of the box.

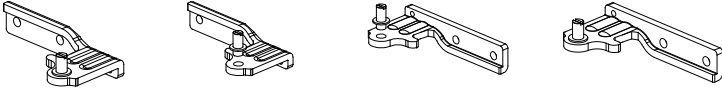

In the order shown above, the center hinge shaft is changed.

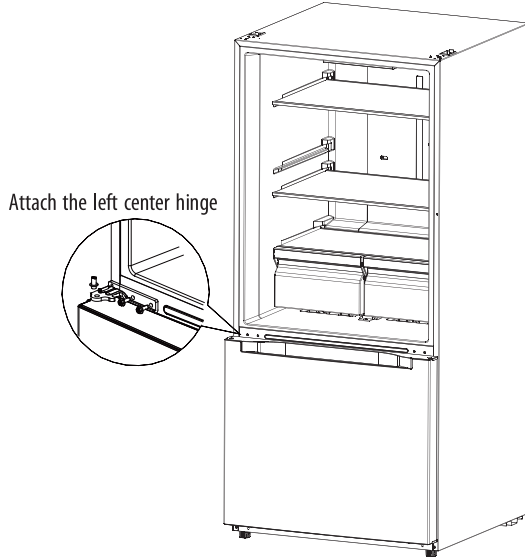

7) Put the refrigerator door vertically down on the middle hinge, then take out the top hinge and cover of other side from accessory bag, assemble top hinge, hinge cover and hole cover.

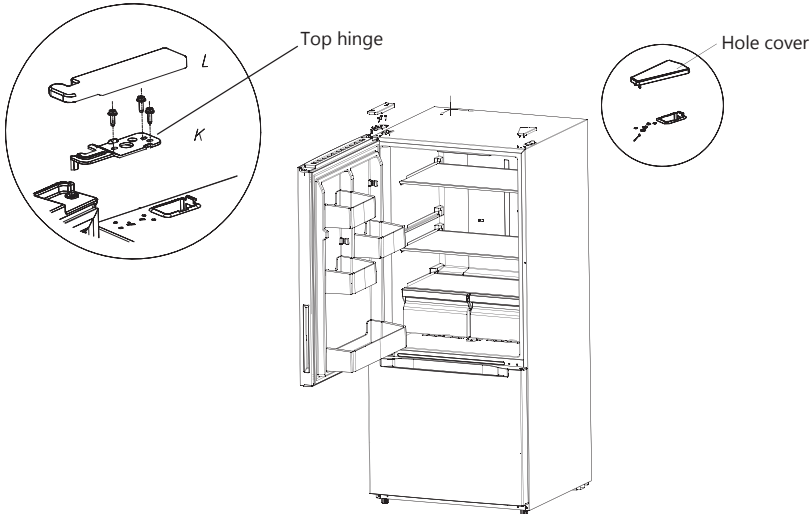

(The picture above is only for reference. The actual configuration will depend on the physical product or statement by the distributor.)

Installing an Optional Ice Maker

Ice maker type:

- This refrigerator can be installed with Element brand ice maker EA1MM19.

Ice maker installation:

- If the refrigerator can be installed with an ice maker, please refer to the ice maker installation instructions provided separately for the installation method of the ice maker. The ice maker is installed by the customer.

2.4 Changing the Light

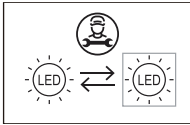

- Any replacement or maintenance of the LED lights is intended to be made by the manufacturer, its service agent or similar qualified person.

2.5 Starting

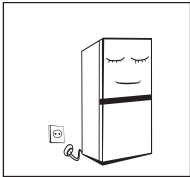

- After transportation, let the product sit for more than 2 hours before turning on the power; otherwise it will lead to a decrease in cooling capacity or damage to the product.
- Before putting any fresh or frozen foods, the refrigerator should run for 2-3 hours, or for above 4 hours in summer when the ambient temperature is high.
- Pull the plug out in case of power failure or cleaning. Do not connect the refrigerator to power supply within five minutes to prevent damages to the compressor due to successive starts.

2.6 Energy saving tips

- The appliance should be located in the coolest area of the room, away from heat producing appliances or heating ducts, and out of the direct sunlight.
- Let hot foods cool to room temperature before placing in the appliance. Overloading the appliance forces the compressor to run longer. Foods that freeze too slowly may lose quality, or spoil.
- Be sure to wrap foods properly, and wipe containers dry before placing them in the appliance. This cuts down on frost build-up inside the appliance.
- Appliance storage bin should not be lined with aluminum foil, wax paper, or paper toweling. Liners interfere with cold air circulation, making the appliance less efficient.
- Organize and label food to reduce door openings and extended searches. Remove as many items as needed at one time, and close the door as soon as possible.

3 Structure and Functions

3.1 Key components

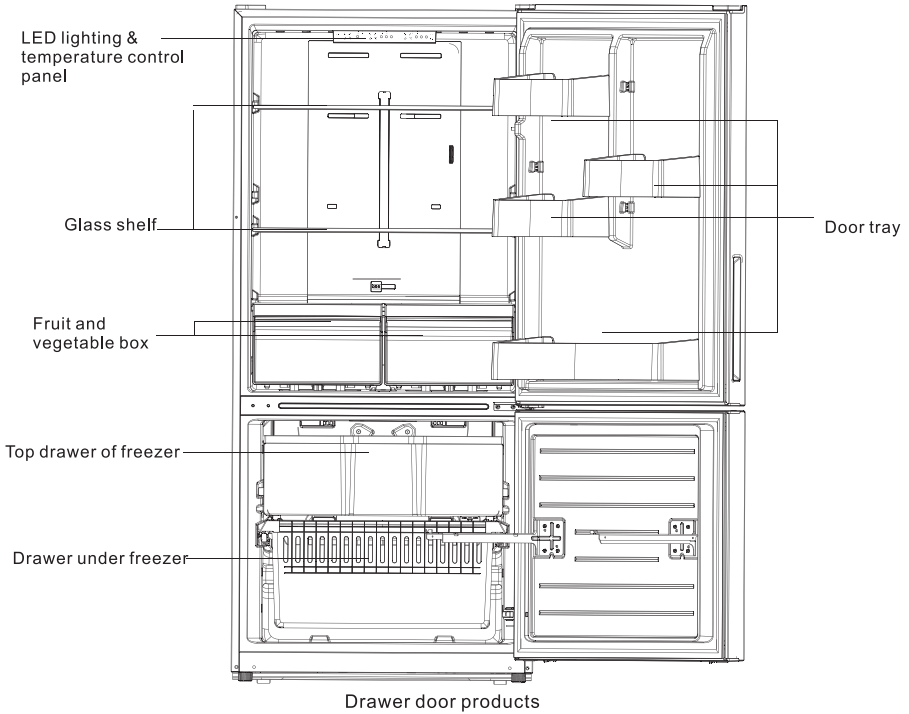

(The picture above is only for reference. The actual configuration will depend on the physical product or statement by the distributor)

Refrigerating chamber

- The refrigerating chamber is suitable for storage of a variety of fruits, vegetables, beverages and other food consumed in the short term.
- Hot food should not be put in the refrigerating chamber until cooled to room temperature.
- It is recommended that all food is sealed before putting into the refrigerator.
- The glass shelves can be adjusted up or down for a reasonable amount of storage space and easy use.

Freezing chamber

- The low temperature freezing chamber may keep food fresh for a long time and it is mainly used to store frozen foods and making ice.
- The freezing chamber is suitable for storage of meat, fish, rice balls and other foods not to be consumed in the short term.
- Chunks of meat are preferably to be divided into small pieces for easy access. Note that food should be consumed within the shelf time.

Note: Storage of too much food during operation after the initial connection to power may adversely affect the freezing effect of the refrigerator. Stored food should not block the air outlet; otherwise the freezing effect will also be adversely affected.

3.2 Functions

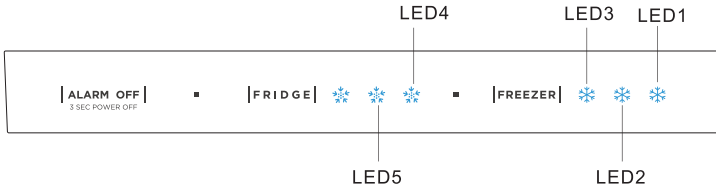

! (The picture above is only for reference. The actual configuration will depend on the physical product or statement by the distributor)

1 Key

- A. Alarm/power off/power on button B. Frozen thermostat button C. Refrigerated thermostat button

2 Display

- When the initial power is up, it is 3 seconds, While the boot bell rings, and then goes into normal operation display. (Refrigerator and freezer are mid-range at the time of first power-up)
- Display fault code in the event of a failure (Loop display); display the set gear of the refrigeration room in the event of trouble-free.
- Under normal circumstances, the current set gear is displayed, and when a "fault code visible" class failure occurs, the fault code is displayed.

3 Operating instructions

1) Refrigerator settings

Press the refrigeration key to adjust the refrigeration set gear, each press the refrigeration key once, the gear change one gear, the order is as follows:



2) Freezer settings

Press the refrigeration key to adjust the refrigeration set gear, each press the refrigeration key once, the gear change one gear, the order is as follows:

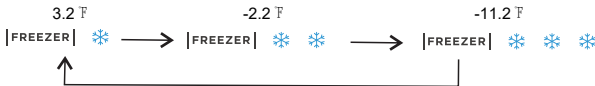

3) Alarm off

When a fault alarm occurs, press the alarm off key short, and the fault alarm sound is canceled.

4) Open the door and alarm

When the freezer door or refrigerator door opens for 120 seconds without shutting down, the buzzer alarms until the freezer door or refrigerator door closes. Or press the alarm off key to cancel the buzzer alarm.

5) Ice maker opens automatically

After 40 seconds of normal operation of the refrigerator, the ice maker opens.

6) Standby mode

Press the alarm off key for 3 seconds to enter standby mode. All loads are turned off and display is off. In standby mode, long press the alarm off for 3 seconds, return to normal control.

- 7) When the freezer frozen humidification paddle is adjusted to the far right, quick-freezing mode close, the freezer fruit and vegetable box can store vegetables, fruits and other items.

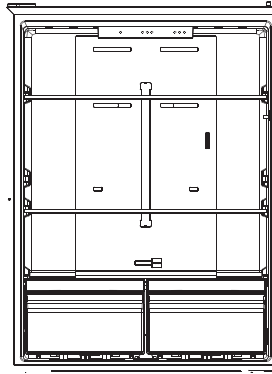

- 8) When the freezer frozen humidification paddle is adjusted to the far left, quick-freezing mode open, the freezer fruit and vegetable box cannot store vegetables, fruits and other easy to freeze bad items, storage drinks and other items.

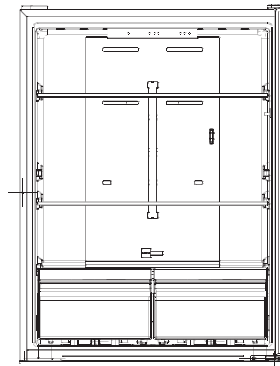

4 Fault indication

The following warnings appearing on the display indicate corresponding faults of the refrigerator. Though the refrigerator may still have refrigerator and freezing function with the following faults, the user should contact maintenance specialist for maintenance, so as to ensure normal use of the refrigerator.

Fault Code	Fault Description
E1	Refrigerator temperature sensor fault LED1/LED2 flashing
E2	Freezer temperature sensor fault LED1/LED5 flashing
E5	Freezing frost sensor faults LED1/LED3 flashing
E6	Communication failure LED2/LED4 flashing
E7	Ring temperature fault LED1/LED4 flashing

4 Maintenance and Care of the Refrigerator

4.1 Overall cleaning

- Dust behind the refrigerator and on the ground should be timely cleaned to improve the cooling effect and energy saving.
- Check the door gasket regularly to make sure there is no debris. Clean the door gasket with a soft cloth dampened with soapy water or diluted detergent.
- The interior of the refrigerator should be cleaned regularly to avoid odor.
- Turn off the power before cleaning interior, remove all foods, drinks ,shelves, drawers, etc.
- Use a soft cloth or sponge, two tablespoons of baking soda and a quart of warm water to clean the inside of the freezer. Rinse with water and wipe clean. After cleaning, open the door and let it dry naturally before turning on the power.
- For areas that are difficult to clean in the refrigerator (such as narrow spaces, gaps, or corners), it is recommended to wipe them regularly with a soft rag, soft brush, etc. and when necessary, combined with some auxiliary tools (such as thin sticks) to ensure no contaminants or bacteria accumulated in these areas.
- Do not use soap, detergent, scrub powder, spray cleaner, etc., as these may cause odors in the interior of the refrigerator or contaminate food.
- Clean the bottle frame, shelves and drawers with a soft cloth dampened with soapy water or diluted detergent. Dry with a soft cloth or dry naturally.
- Wipe the outer surface of the refrigerator with a soft cloth dampened with soapy water, detergent, etc., and then wipe dry.
- Do not use hard brushes, clean steel balls, wire brushes, abrasives (such as toothpastes), organic solvents (such as alcohol, acetone, banana oil, etc.), boiling water, acid or alkaline items, which may damage the fridge surface and interior. Boiling water and organic solvents such as benzene may deform or damage plastic parts.
- Do not rinse directly with water or other liquids during cleaning to avoid short circuits or affect electrical insulation after immersion.



 Unplug the refrigerator for defrost and cleaning.

4.2 Cleaning of door tray

- According to the direction arrow in the figure below, use both hands to squeeze the tray, and push it upward, then take it out.
- After washing the tray having been taken out, you can adjust its installing height in accordance with your requirement.

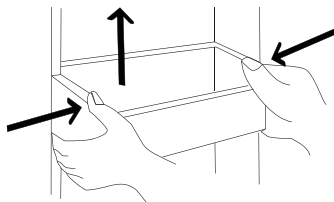

(The picture above is only for reference. The actual configuration will depend on the physical product or statement by the distributor.)

4.3 Glass shelf cleaning

Since the shelf and box gill have the innermost stop, first lift the shelf up. Then pull the shelf outward so it can be removed. Clean and adjust as needed.

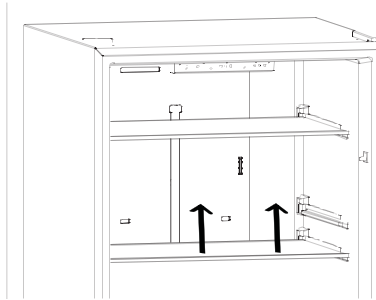

4.4 Box gill bottom roller groove cleaning

1. First pull out the fruit and vegetable box. Because the fruit and vegetable box has a stop, it needs to be lifted upward before the fruit and vegetable box can be removed.

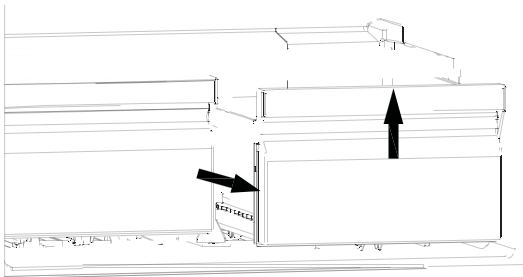

2. The roller seat is stuck in the box tank groove, press the arrow in the direction of the image, remove the roller seat, clean the box tank groove as needed.

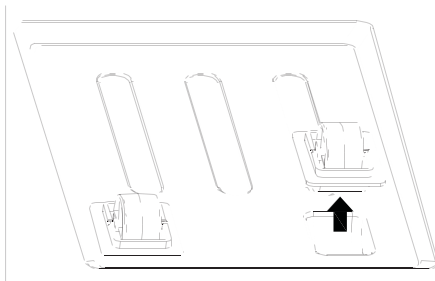

4.5 Defrosting

- The refrigerator is made based on the air-cooling principle and has an automatic defrosting function. Frost formed due to change of season or temperature may also be manually removed by disconnection of the appliance from power supply or by wiping with a dry towel.

4.6 Out of operation

- Power failure: In case of power failure, even if it is summer, food inside the appliance can be kept for several hours. During the power failure, the amount of times the door opens should be reduced and no more fresh food should be put into the appliance.
- Long-time nonuse: The appliance should be unplugged and then cleaned; then the doors are left open to prevent odor.
- Moving: Before the refrigerator is moved, take all objects inside out, fix the glass partitions, vegetable holder, freezing chamber drawers and etc. with tape, and tighten the levelling feet; close the doors and seal them with tape. During moving, the appliance should not be laid upside down, horizontally, or be vibrated. The inclination during movement should be no more than 45°.

 The appliance should run continuously once it is started. Generally, the operation of the appliance should not be interrupted; otherwise the service life may be impaired

5 Troubleshooting

You may try to solve the following simple problems by yourself. If the problems cannot be solved, contact the after-sales department.

Failed operation	<p>Check whether the appliance is connected to power or whether the plug is in well contact .</p> <p>Check whether the voltage is too low.</p> <p>Check whether there is a power failure or partial circuits have tripped.</p>
Odor	<p>Odorous foods should be tightly wrapped.</p> <p>Check whether there is any rotten food.</p> <p>Clean the inside of the refrigerator.</p>
Long-time operation of the compressor	<p>Long operation of the refrigerator is normal in summer when the ambient temperature is high.</p> <p>It is not recommended having too much food in the appliance at the same time.</p> <p>Food should get cool before being put into the appliance.</p> <p>The doors are opened too frequently.</p>
Light fails to get lit	<p>Check whether the refrigerator is connected to power supply and whether the illuminating light is damaged.</p>
Doors cannot be properly closed	<p>The door is stuck by food packages.</p> <p>The refrigerator is tilted.</p>
Loud noise	<p>Check whether the floor is level and whether the refrigerator is placed stably.</p> <p>Check whether accessories are placed at proper locations.</p>
Door seal fails to be tight	<p>Remove foreign matters on the door seal.</p> <p>Heat the door seal and then cool it for restoration (or blow it with an electrical drier or use a hot towel for heating).</p>
Water pan overflows	<p>There is too much food in the chamber or food stored contains too much water,resulting in heavy defrosting.</p> <p>The doors are not closed properly, resulting in frosting due to entry of air and increased water due to defrosting.</p>
Hot housing	<p>Heat dissipation of the built-in condenser via the housing, which is normal.</p> <p>When housing becomes hot due to high ambient temperature and storage of too much food,it is recommended to provide sound ventilation to facilitate heat dissipation.</p>
Surface condensation	<p>Condensation on the exterior surface and door seals of the refrigerator is normal when the ambient humidity is too high. Just wipe the condensate with a clean towel.</p>
Abnormal noise	<p>Buzz: The compressor may produce buzzes during operation, and the buzzes are loud particularly upon start or stop. This is normal.</p> <p>Creak: Refrigerant flowing inside of the appliance may produce creak, which is normal.</p>

6 Warranty

6.1 Warranty

Element Appliance Limited Warranty

(the “Products” or “Product” when referencing a singular product herein)

This Product (including any accessories included in the original packaging) as supplied and distributed in new condition, is warranted by Element Appliance Company, LLC (“Element”) to the original customer who purchases the Product from an authorized Element retailer (the “Original Customer” or “you”) against defects in material and workmanship under proper use, maintenance, and care according to the owner’s manual, warnings, and instructions accompanying the Product (“Warranty”) as follows:

* **PLEASE NOTE** – Proof of purchase evidencing the date of purchase by the Original Purchaser from an authorized Element retailer (“Valid Proof of Purchase”) is **required** for all Warranty service. The express Warranty set forth herein is subject to all terms and conditions set forth below.

1. WARRANTY SERVICE:

A. ONE-YEAR WARRANTY: Except as provided in subpart 1.B below, for a period of **one (1) year** from the date of purchase by the Original Customer (the “Warranty Period”), if the parts or components covered by this Warranty are determined by Element or Element’s authorized service provider to be defective in material or workmanship, Element will, at its sole and absolute discretion and option: (i) repair the defective part or component at no charge to the Original Customer, (ii) replace the defective Product with a new Product of similar or better quality, at no charge to the Original Customer, or (iii) refund the documented purchase price paid by the Original Customer (excluding tax) to the Original Customer upon return of the defective Product as directed by Element. After the Warranty Period expires, the Original Customer must pay for all parts, components, shipping and handling, labor, and replacement costs associated with the Product or any part or component thereof, regardless of any defects in the Product or any part or component thereof.

B. LIMITED EXTENDED WARRANTY THROUGH PRODUCT REGISTRATION: If and only if the Original Customer registers the Product at www.elementelectronics.com within **ninety (90)** days of the date of purchase by the Original Customer, then the Warranty Period discussed in subpart 1.A. above shall be extended an additional one (1) year to a new Warranty Period equaling **two (2) years** from the date of purchase by the Original Customer. If the Product is not registered as provided for in this subpart 1.B, then the standard one-year Warranty Period set forth in subpart 1.A shall apply.

C. TIMING AND PROCEDURE: Before Warranty service can commence, the Original Customer must contact either (i) the retailer from whom the Original Customer purchased the Product, or (ii) Element directly, in either case for problem determination and service procedures. Valid Proof of Purchase evidencing that the Product is within the Warranty Period **MUST** be presented by Original Customer in order to obtain the requested Warranty service. Please have your model and serial number available, along with your date of purchase of the Product. To remain eligible for Warranty service, Original Customer may not return the Product or any part or component thereof to the retailer or Element without Element’s prior written consent.

2. EXCLUSIONS AND LIMITATIONS TO WARRANTY SERVICE

The Warranty covers manufacturing defects in materials and workmanship of the Product encountered in the normal, non-commercial use of the Product, and **does not cover** (a) damages or malfunctions resulting from improper or unreasonable use or maintenance, abuse, negligence, failure to follow instructions contained in any written materials that accompany the Product, deterioration by reason of excess moisture, corrosive atmosphere, lightning, power surges, connections to improper voltage supply, unauthorized alteration, or other external causes such as extremes in temperature or humidity, modifications, scratches or discoloration; (b) any damage caused by using non-authorized parts or service facilities for repair of Products (however, for avoidance of doubt, using non-authorized parts or service facilities will not, in and of itself, void the Warranty); (c) transportation, shipping, delivery, pickup, insurance, installation, or set-up costs; (d) ordinary wear and tear, cosmetic damage, or damage due to acts of nature, including but not limited to, water, floods, wind, storm, tornado, earthquake, or fire, or due to damage caused by extraordinary impact events, such as dropping, crushing, demolition or other extraordinary damage; (e) commercial use of the Product, or use of the Product for anything other than single-family household or residential use; or (f) modification of the Product or any part of the Product.

This Warranty is made to the Original Customer only and does not cover Products sold AS IS or WITH ALL FAULTS. The Warranty is invalid if the factory-applied serial number has been altered or removed from the Product. This Warranty is valid only in the United States, and only applies to Product if it was purchased and serviced in the United States. The addition of equipment or features to the Product that are not manufactured or recommended by Element could affect the intended function of the Product, and therefore may void the Warranty. Furthermore, the exposure of the Product to chemicals, heat, cold, humidity, or other elements can affect the Product components, and therefore, the Warranty does not cover discoloration, fading, cosmetic changes, rust, or any damages or failure related to any such items. The Warranty is contingent upon the proper use, maintenance, and care of the Product. The Warranty may be void if the Product has been used in a manner contradictory to, or in violation of, the terms of the user's manual, warnings, or instructions accompanying the Product.

THIS WARRANTY IS MADE IN LIEU OF AND SUPERSEDES ALL OTHER WARRANTIES OR CONDITIONS OF MERCHANTABILITY OR FITNESS FOR A PARTICULAR PURPOSE OR GENERAL USE, WHETHER EXPRESS, IMPLIED, COLLATERAL, STATUTORY, OR PROVIDED BY COMMON LAW, THE UNIFORM COMMERCIAL CODE, OR OTHERWISE. ELEMENT FURTHER DISCLAIMS ALL WARRANTIES AFTER THE END OF THE WARRANTY TERM DEFINED ABOVE. NO OTHER EXPRESS WARRANTY OR GUARANTY GIVEN BY ANY OTHER PERSON, FIRM, OR ENTITY WITH RESPECT TO THE PRODUCT SHALL BE BINDING ON ELEMENT. REPAIR, REPLACEMENT, OR REFUND OF THE ORIGINAL PURCHASE PRICE, AT ELEMENT'S SOLE DISCRETION, ARE THE EXCLUSIVE REMEDIES OF THE CUSTOMER.

ELEMENT SHALL NOT BE LIABLE FOR ANY INCIDENTAL OR CONSEQUENTIAL DAMAGES CAUSED BY THE USE, MISUSE, OR INABILITY TO USE THE PRODUCT. THESE INCLUDE, BUT ARE NOT LIMITED TO, ANY DAMAGES IN THE FORM OF LOST PROFITS, LOSS OF USE, LEGAL FEES, ECONOMIC LOSS, PERSONAL INJURIES, OR ANY OTHER DAMAGES CAUSED BY CIRCUMSTANCES BEYOND THE CONTROL OF ELEMENT. NOTWITHSTANDING THE FOREGOING, ELEMENT'S AGGREGATE LIABILITY TO ANY CUSTOMER SHALL NOT EXCEED THE ORIGINAL PURCHASE PRICE OF THE PRODUCT. THIS WARRANTY SHALL NOT EXTEND TO ANYONE OTHER THAN THE ORIGINAL CUSTOMER WHO PURCHASED THE PRODUCT, AND IS NOT

TRANSFERRABLE. NO PERSON IS AUTHORIZED TO ALTER, EXTEND, OR WAIVE THIS WARRANTY OR ANY OF ITS TERMS OR CONDITIONS.

Some states do not allow the exclusion or limitation of incidental or consequential damages, or allow limitations on warranties, so the above limitations or exclusions may not apply to you. This Warranty gives you specific rights, and you may have other rights, which vary from state to state. The exclusions and limitations to the Warranty apply to the maximum extent permitted by law and unless restricted or prohibited by law. Where any term of this Warranty is prohibited by applicable law, it shall be null and void, but the remainder of this Warranty shall remain in effect.

PLEASE DIRECT ALL CORRESPONDENCE TO:

Element Appliance Company, LLC
customerservice@elementelectronics.com
(888) 842-3577
<https://elementelectronics.com>



Element, the Element Logo, and Bring it home are trademarks of Element Brand Holding, LLC. All other trademarks are the property of their respective owner, who has not sponsored, endorsed, or approved this product. ©2024 Element Appliance Company, LLC. All rights reserved.

Distributed by Element Appliance Company, LLC
Augusta, GA 30909

For service, support and warranty information:
Call 888.842.3577, email us at customerservice@elementelectronics.com
or visit www.elementelectronics.com