

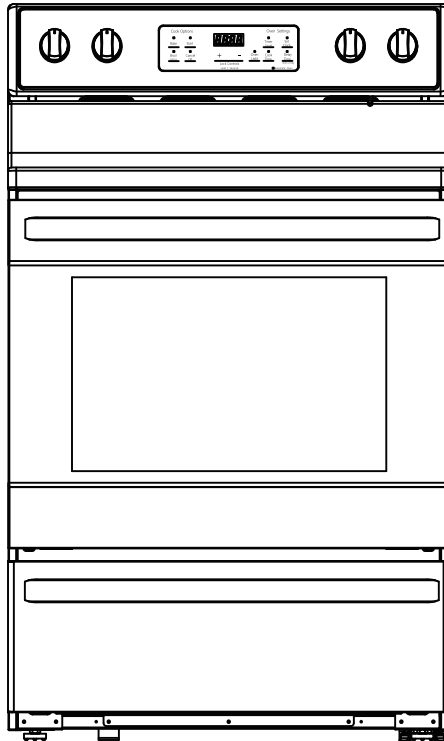

# 30" Standard Electric Range Installation Manual



**EER34MSCW/EER34MSCS/EER34MSCB**

## **INSTALLATION MANUAL**

**▲CAUTION:** To Reduce The Risk Of Injury, User Must Read And Understand Operators Manual. Save These Instructions For Future Reference.



# TABLE OF CONTENTS

**SAFETY INFORMATION . . . . . 3**

Symbol Meaning . . . . . 3

**INSTALLATION REQUIREMENTS . . . . . 4**

Tools/Parts Needed . . . . . 4

Mobile Home Installation Requirement . . . . . 5

Product Dimensions . . . . . 5

Cabinet Dimensions . . . . . 5

Electrical Requirements . . . . . 6

Electrical Connection . . . . . 7

**INSTALLATION INSTRUCTIONS . . . . . 8**

Anti-Tip Bracket . . . . . 8

How to Install Anti-Tip Bracket . . . . . 8

Floor / Wall Mounting: . . . . . 8

Oven Door . . . . . 9

How To Remove Oven Door: . . . . . 9

How To Reinstall The Oven Door: . . . . . 9

Level Range . . . . . 10

How To Level The Range: . . . . . 10

**ELECTRICAL CONNECTION . . . . . 11**

Before: Power Cord and Conduit . . . . . 12

For Power Cord Installation . . . . . 12

For Conduit Installation . . . . . 12

3-Wire Cable from Home Power Supply . . . . . 13

For Power Cord Installation . . . . . 13

For Conduit Installation . . . . . 13

**NOTES . . . . . 14**

**RTI:**  
**INSTALLER:** LEAVE INSTALLATION INSTRUCTIONS WITH THE HOMEOWNER.  
**HOMEOWNER:**  
 KEEP INSTALLATION INSTRUCTIONS FOR FUTURE REFERENCE.



# SAFETY INFORMATION

**FOR YOUR SAFETY AND THE SAFETY OF OTHERS, PLEASE READ ALL SAFETY INSTRUCTIONS BEFORE INSTALLING THIS APPLIANCE.**

There are important safety messages in this manual for this appliance. Failure to follow instructions may result in potential safety hazards to you or to the product, which may cause bodily injury. All safety messages will explain what the potential hazards are, explain how to reduce the chance of injury, and state what can happen if the instructions are not followed.

## SYMBOL MEANING

**ALL SAFETY MESSAGES WILL TELL YOU WHAT THE POTENTIAL HAZARD IS, WILL TELL YOU HOW TO REDUCE THE CHANCE OF INJURY, AND TELL YOU WHAT CAN HAPPEN IF THE INSTRUCTIONS ARE NOT FOLLOWED.**

	This is the safety alert symbol.
	This symbol alerts you to potential hazards that can hurt or kill you and others.
	All safety messages will follow the safety alert symbol with either the word: DANGER or WARNING.

**DANGER:** YOU MAY BE SERIOUSLY INJURED OR KILLED IF YOU DO NOT IMMEDIATELY FOLLOW INSTRUCTIONS!

**WARNING:** YOU MAY BE SERIOUSLY INJURED OR KILLED IF YOU DO NOT FOLLOW INSTRUCTIONS!

<b> WARNING:</b>	<b>TIP OVER HAZARD</b>
	<p>A child or adult can tip the range and be killed. Make sure the anti-tip bracket has been properly installed and secured per the installation instructions. Re-secure the anti-tip bracket if range is moved. Do not operate the range without the anti-tip bracket installed and secured. Failure to follow these instructions can result in death or serious burns to adults and children.</p>
	<p><b>TO VERIFY THE ANTI-TIP BRACKET IS INSTALLED AND SECURED PROPERLY:</b></p> <ol style="list-style-type: none"> <li>1. Slide range forward</li> <li>2. Look for the anti-tip bracket attached to the floor or wall, then slide range back so rear range foot is under anti-tip bracket.</li> <li>3. If the range can be tipped away from the wall, the range has not been secured in place. Repeat steps 1-2 to ensure rear range foot is set properly.</li> </ol>
<b> WARNING:</b>	<p><b>REMOVE PACKAGING MATERIALS</b></p> <p>Before installation, remember to remove all the packaging material from the interior and exterior parts of the range, including inside the oven. Failure to remove packaging materials may result in damage or injury.</p>

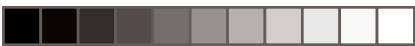

# INSTALLATION REQUIREMENTS

Before beginning the installation process, gather all the required tools and parts. Read and follow the instructions as provided.

**IMPORTANT:** Remember to remove all the packaging material from the interior and exterior parts of the oven before connecting the gas or electrical supply.

**TOOLS/PARTS NEEDED:**

Tape Measure	Hammer	15/16" Combination Wrench
Flathead Screwdriver	Pipe Wrench	1/4" Drive Ratchet
Phillips Screwdriver	Wrench or Pliers	3/8" Nut Driver
Level	Marker or Pencil	1/8" (3.2 mm) drill bit (for wood floors)
Hand or Electric Drill		

**PARTS SUPPLIED**

Check that all parts are included. Anti-tip bracket must be securely mounted to floor or wall. Thickness of flooring may require longer screws to anchor bracket to the floor.

- A. Anti-tip bracket
- B. #10 x 1-7/8" screws (2)

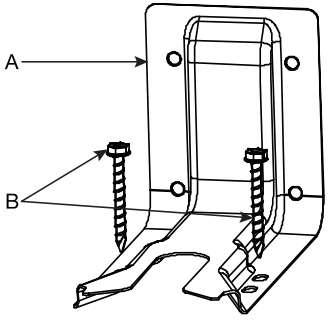

**PART YOU WILL NEED (sold separately):**

UL Listed Power Cord

**LOCATION REQUIREMENTS**

**IMPORTANT:**

- Observe all governing codes and ordinances.
- Do not obstruct flow of combustion and ventilation air.
- It is the installers responsibility to comply with installation clearances

specified on the model/serial rating plate. The Model/Serial rating plate is located on the oven frame behind the top left side of the Oven Drawer door. You can also find the same model/serial rating plate on the back of the oven.

Recessed installations must provide complete enclosure of the sides and rear of the range.

All openings in the wall or floor where range is to be installed must be sealed.

Do not seal the range to the side cabinets.

Cabinet opening dimensions that are shown must be used.

Given dimensions are minimum clearances.

The floor anti-tip bracket must be installed. To install the anti-tip bracket shipped with the range, see Install Anti-Tip Bracket section.

Grounded electrical supply is required. See Electrical Requirements section.

Contact a qualified floor covering installer to check that the floor covering can withstand at least 200°F (93°C).

Use an insulated pad or 1/4" (0.64 cm) plywood under range if installing range over carpeting.

**IMPORTANT:**  
**TO AVOID DAMAGE TO YOUR CABINETS, CHECK WITH YOUR BUILDER OR CABINET SUPPLIER TO MAKE SURE THAT THE MATERIALS USED WILL NOT DISCOLOR, OR SUSTAIN OTHER DAMAGE.**

## INSTALLATION REQUIREMENTS (continued)

This oven has been designed in accordance with the requirements of UL and CSA International and complies with the maximum allowable wood cabinet temperatures of 194°F (90°C).

### MOBILE HOME INSTALLATION REQUIREMENT:

When this range is installed in a mobile home, it must be secured according to the instructions in this manual.

### PRODUCT DIMENSIONS

- A. 25.63" (65.1 cm) depth. Back of range to front of cooktop
- B. 28.5" (72.4 cm) max. depth with handle
- C. 46.26" (117.5 cm) overall height (max.) with leveling legs
- D. 29.87" (75.9 cm) width
- E. 35.9" (91.2 cm) cooktop height (max.) with leveling legs

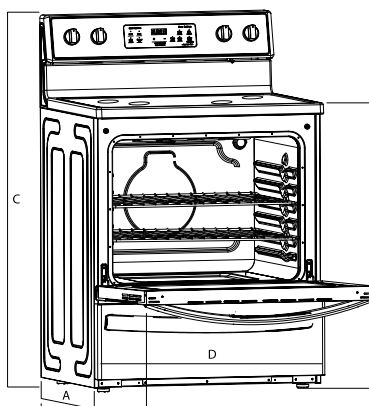

### IMPORTANT:

Range must be level after installation. Follow the instructions in the Level Range section. Using the cooktop as a reference for leveling the range is not recommended. Range can be raised approximately 1.18" (3 cm) by adjusting the leveling legs. Front of door and drawer may extend farther forward depending on styling.

### CABINET DIMENSIONS

Cabinet opening dimensions shown are for 26" (66.0 cm) countertop depth, 24" (61.0 cm) base cabinet depth and 36" (91.4 cm) countertop height.

- A. 18" (45.7 cm) upper side cabinet to countertop
- B. 13" (33 cm) maximum upper cabinet depth
- C. 30-1/8" (76.5 cm) minimum opening width
- D. For minimum clearance to top of cooktop, see \*NOTE below.
- E. 30-1/8" (76.5 cm) minimum opening width
- F. 3" (7.6 cm) minimum clearance from both sides of range to side wall or other combustible material.
- G. 27" (68.7 cm)
- H. 7-4/5" (19.8 cm)
- I. 3-1/5" (8 cm)
- J. Cabinet door or hinges should not extend into the cutout.
- K. 24" (61.0 cm) base cabinet depth
- L. 26" (66.0 cm) tabletop width of base cabinet

**\*NOTE:** Allow 30" minimum clearance between surface units and bottom of unprotected wood or metal cabinet, or allow a 24" (61.0 cm) minimum when bottom of wood or metal cabinet is protected by no less than 1/4" (0.64 cm) thick flame retardant millboard covered with not less than No 28 MSG sheet metal [0.015" (0.4 mm)], 0.015" (0.4 mm) thick stainless steel, 0.024" (0.6 mm) aluminum or 0.020" (0.5 mm) copper.

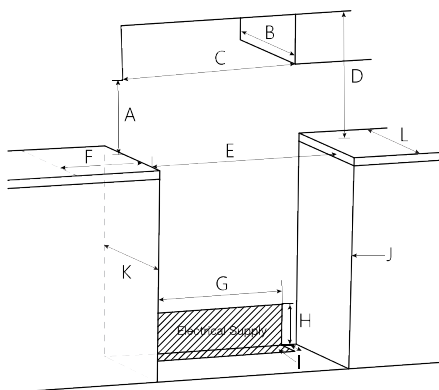



# INSTALLATION REQUIREMENTS (continued)

## ELECTRICAL REQUIREMENTS

<b>▲WARNING:</b>	<b>ELECTRICAL SHOCK HAZARD</b>
	<p>Plug into a grounded 3-prong or 4-prong outlet.</p> <p>Do not remove ground prong.</p> <p>Do not use adapter.</p> <p>Do not use an extension cord.</p> <p>Failure to follow these instructions can result in death, fire and/or electric shock. Also, may damage the stove</p>

### IMPORTANT

Check with your local utilities for electrical codes which apply in your area. Failure to wire your oven according to governing codes could result in a hazardous condition. If there are no local codes, your oven must be wired and fused to meet the National Electrical Code, NFPA No. 70 latest edition, available from the National Fire Protection Association.

If codes permit and a separate ground wire is used, it is recommended that a qualified electrical installer determine that the ground path is adequate.

You must use a single-phase, 120/208 VAC or 120/240 VAC, 60 hertz electrical system. If you connect to aluminum wiring, properly installed connectors approved for use with aluminum wiring must be used.

The wiring diagram is located on the back of the oven.

**NOTE:** The metal chassis of the range must be grounded for the control panel to work. If the metal chassis of the range is not grounded, no keypads will operate. Check with a qualified electrician if you are in doubt as to whether the metal chassis of the range is grounded.

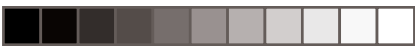

# INSTALLATION REQUIREMENTS (continued)

## ELECTRICAL CONNECTION

To properly install your oven, you must determine the type of electrical connection you will be using and follow the instructions provided for it here.

Range must be connected to the proper electrical voltage and frequency as specified on the model/serial number rating plate. The Model/Serial rating plate is located on the oven frame behind the top left side of the Oven Drawer door. The Wiring Diagram is located on the back of the oven.

Connect directly to the circuit breaker box (or fused disconnect) through flexible, nonmetallic sheathed, copper cable (with grounding wire). See Electrical Connection section.

Flexible conduit from the oven should be connected directly to the junction box.

Fuse both sides of the line.

Do not cut the conduit. The length of conduit provided is for serviceability of the oven.

A UL listed or CSA approved conduit connector must be provided.

If the house has aluminum wiring, follow the procedure below:

1. Connect a section of solid copper wire to the ends of the flexible conduit leads.
2. Connect the aluminum wiring to the added section of copper wire using special connectors and/or tools designed and UL listed for joining copper to aluminum. Follow the electrical connector manufacturer's recommended procedure. Aluminum/copper connection must conform with local codes and industry accepted wiring practices.

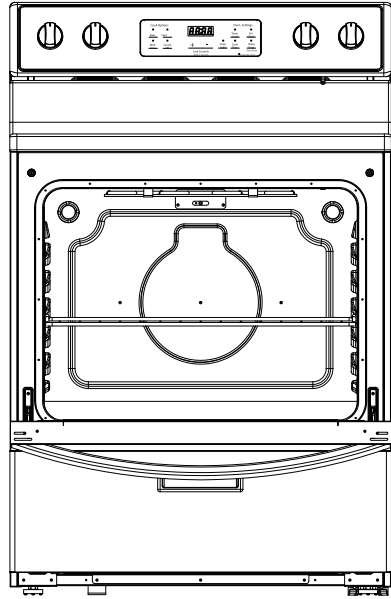

For power requirements, refer to the following table.

VOLTAGE	SINGLE TERMINAL
120 / 208 VAC	7238W
120 / 208 VAC	34.8 A / 39 A
120 / 240 VAC	9650 W
120 / 240 VAC	40.21A / 50A



# INSTALLATION INSTRUCTIONS

## ANTI-TIP BRACKET

<p><b>▲WARNING:</b></p>	<p><b>TIP OVER HAZARD</b></p>
	<p>A child or adult can tip the range and be killed.</p> <p>Make sure the anti-tip bracket has been properly installed and secured per the installation instructions.</p> <p>Slide range back so rear range foot is engaged in the slot of the anti-tip bracket.</p> <p>Re-secure the anti-tip bracket if range is moved.</p> <p><b>DO NOT OPERATE THE RANGE WITHOUT THE ANTI-TIP BRACKET INSTALLED AND SECURED.</b></p> <p>Failure to follow these instructions can result in death or serious burns to adults and children.</p>

## HOW TO INSTALL ANTI-TIP BRACKET

1. Remove the anti-tip bracket from where it is taped on Oven Rack inside the Oven.
2. Determine which mounting method to use: floor or wall. If you have a stone or masonry floor, you can use the wall mounting method. If you are installing the range in a mobile home, you must secure the range to the floor.
3. Determine and mark centerline of the cutout space. The mounting can be installed on either the left side or right side of the cutout. Position mounting bracket against the wall in the cutout so that the V-notch of the bracket is 13-1/9" (33.3 cm) from centerline as shown.
4. Drill two 1/8" (3 mm) holes that correspond to the bracket holes of the determined mounting method. See the following illustrations.

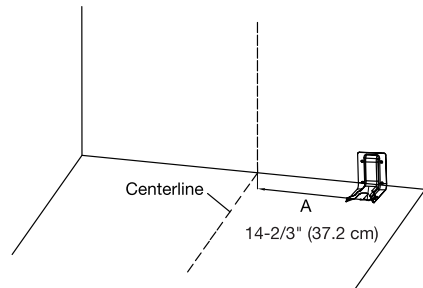

## FLOOR / WALL MOUNTING:

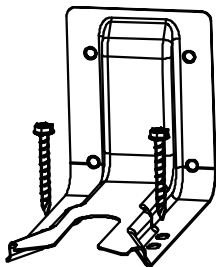

Front / Floor Position

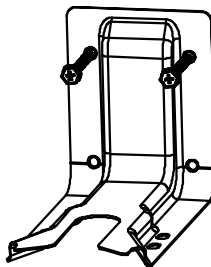

Rear / Wall Position

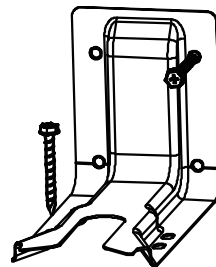

Diagonal (2 Options)







## INSTALLATION INSTRUCTIONS (continued)

### OVEN DOOR

#### HOW TO REMOVE OVEN DOOR:

**IMPORTANT:** Use both hands to remove oven door(s).

1. Open the oven door fully so it is at a 90 degree angle.
2. Next, locate the oven door latches in both corners of the oven door, then flip up the hinge latch on each side to the unlocked position. (See diagram below). Pliers may be required to unlock hinges.
3. Once the latch is in the unlocked position, grasp the oven door with both hands, and then gently close the oven door to as far as it will shut.
4. Using both hands, lift and pull the oven door towards you and remove.
5. Set the oven door(s) aside on a covered work surface.

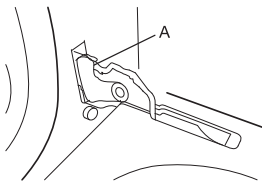

A. Oven door hinge latch in locked position

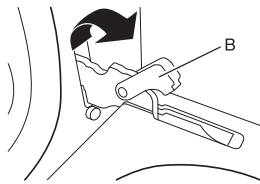

B. Oven door hinge latch in unlocked position

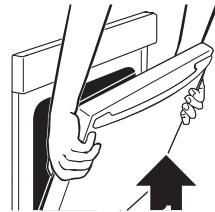

#### HOW TO REINSTALL THE OVEN DOOR:

1. To reinstall the oven door, insert both hanger arms of the oven door into the range. The hinge latches on both sides should be in the unlocked position before inserting hanger arms into the range.
2. Once the hanger arms are placed into the range, open the oven door fully.
3. Next, locate the hinge lever latches, move them back to the locked position. It is recommended to use a rubber mallet to ensure hinges are securely locked into place.
4. Once the oven door levers are locked, gently close the door and check that the door can open and close with no issues.
5. Check to see if there are any gaps on both sides of the oven door. If there are gaps, the door has not been reinstalled correctly. Repeat the removal and installation procedure.





## INSTALLATION INSTRUCTIONS (continued)

### LEVEL RANGE

#### HOW TO LEVEL THE RANGE:

1. To level your range, place a level straight across (left to right), on one of the racks inside your oven. If the range is uneven, adjust the leveling legs until the level is balanced. (Leveling legs are on the bottom of the range and can be adjusted by turning feet clockwise or counterclockwise.

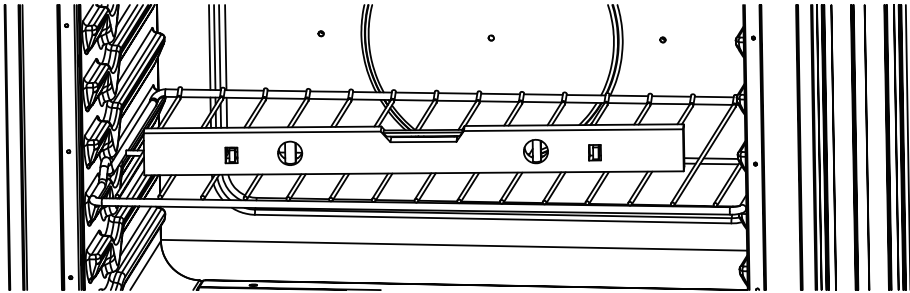

2. Once you have checked the levelness from left to right, take another reading by moving the level and placing it diagonally across the bottom of the oven. If the range is still uneven, adjust the leveling legs again until all angles on the level are balanced.

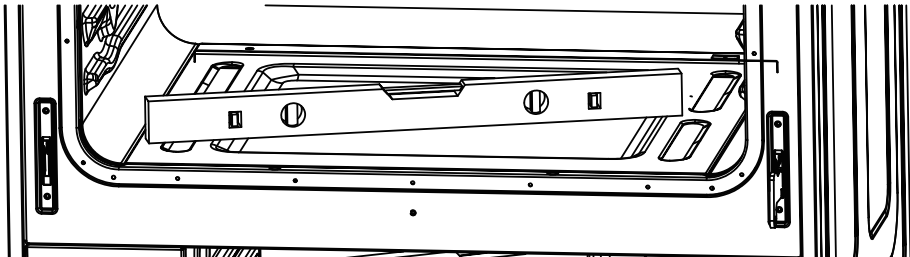



# ELECTRICAL CONNECTION

<div style="border: 1px solid black; padding: 5px; display: inline-block;"><b>⚠ WARNING:</b></div>	<p style="text-align: center;"><b>ELECTRICAL SHOCK HAZARD</b></p> <p>Disconnect power before servicing.          Use a new 50 amp power supply cord.          Use 8 gauge copper or 6 gauge aluminum wire.          Electrical ground range.          Plug into a grounded outlet.          Failure to follow these instructions can result in death,          fire or electrical shock.</p>
	

This oven is manufactured with a neutral (white) power supply wire and a cabinet-connected green (or bare) ground wire twisted together.

- A. To access the terminal block, remove the terminal block cover by removing screws using a phillips screwdriver. Do not discard these screws.
- B. For power cord and 1" conduit only, remove the knockout ring [1-3/8" (3.5 cm)] located on bracket directly below the terminal block. To remove the knockout, use a pair of pliers to bend the knockout ring away from the bracket and twist until the ring is removed.
- C. For power cord installations only (see the next step if using conduit), assemble the strain relief in the hole. Insert the power cord through the strain relief and tighten. Allow enough slack to easily attach the cord terminals to the terminal block. If tabs are present at the end of the winged strain relief, they can be removed for better fit.

**NOTE:** Do not install the power cord without a strain relief. The strain relief bracket **MUST** be installed before reinstalling the terminal block cover. You **MUST** purchase a cord at the desired length that matches the receptacle configuration correctly.

**NOTE:** Next to this knockout ring [1-3/8" (3.5 cm) ], a knockout ring [1-1/8" (2.9 cm)] is reserved for installation to match some models of power cord and conduit.

- D. For 3/4" conduit installations only, purchase a squeeze connector matching the diameter of your conduit and assemble it in the hole. Insert the conduit through the squeeze connector and tighten. Allow enough slack to easily attach the wires to the terminal block.

**NOTE:** Do not install the conduit without a squeeze connector.

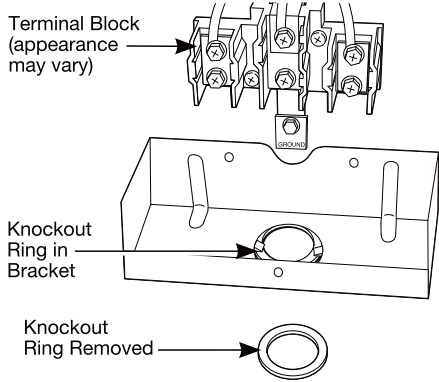
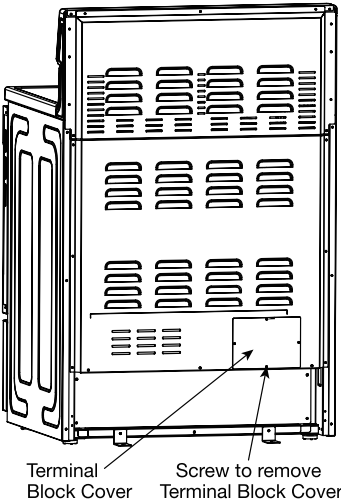



## ELECTRICAL CONNECTION (continued)

The squeeze connector **MUST** be installed before reinstalling the terminal block cover.

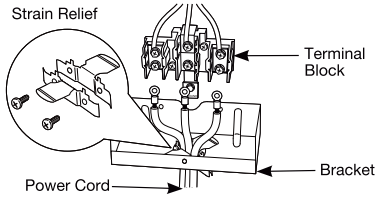

- E. Replace wire cover on range back and replace the screws removed earlier. Make sure that no wires are pinched between cover and range back. Replace the terminal block cover if it was removed.

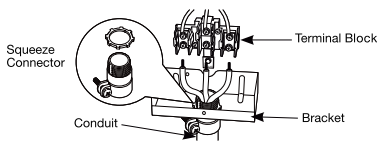

**4-Wire Cable from Home Power Supply**  
**IMPORTANT:** The neutral wire of the supply circuit must be connected to the neutral terminal located in the lower center of the terminal block. The power leads must be connected to the lower left and the lower right terminals of the terminal block. The grounding lead must be connected to the frame of the range with the ground plate and the green ground screw.

### BEFORE: POWER CORD AND CONDUIT

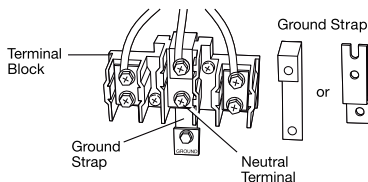

### FOR POWER CORD INSTALLATION

- Remove the 3 lower terminal screws from the terminal block. Remove the ground screw and ground plate and retain them. Cut and discard the ground strap. **DO NOT DISCARD ANY SCREWS.**
- Insert the one ground screw into the power cord ground wire terminal ring, through the ground plate and into the frame of the range.
- Insert the 3 terminal screws (removed earlier) through each power cord terminal ring and into the lower terminals of the terminal block. Be certain that the center wire (white/neutral) is connected to the center lower position of the terminal block. Tighten screws securely into the terminal block. Do not overtighten the screws.

After: Power Cord

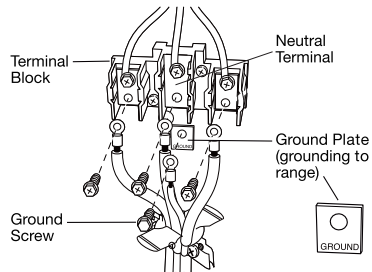

### FOR CONDUIT INSTALLATION

- Loosen the 3 lower terminal screws on the terminal block. Strip wire to exposed tip about 5/8" long.
- Insert the center (white/neutral) wire tip through the bottom center terminal block opening. On certain models, the wire will need to be inserted through the ground strap opening and then into the bottom center block opening. Insert the two side bare wire tips into the lower left and the lower right terminal block openings.
- Tighten the screws until the wire is firmly secured (35 to 50 inch-lbs.). Do not overtighten the screws.



# ELECTRICAL CONNECTION (continued)

After: Conduit

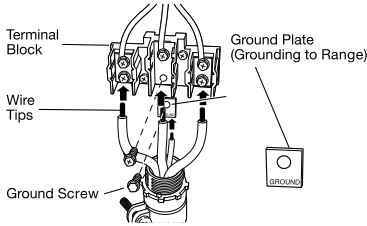

**NOTE: ALUMINUM WIRING:** Aluminum building wire may be used but it must be rated for the correct amperage and voltage.

## 3-WIRE CABLE FROM HOME POWER SUPPLY

**IMPORTANT:** The neutral or ground wire of the power cord must be connected to the neutral terminal located in the lower center of the terminal block and the ground strap must connect the neutral terminal to the ground plate. The power leads must be connected to the lower left and the lower right terminals of the terminal block.

DO NOT remove the ground strap connection.

### FOR POWER CORD INSTALLATION

- Remove the 3 lower terminal screws from the terminal block.
- Insert the 3 terminal screws through each power cord terminal ring and into the lower terminals of the terminal block. Be certain that the center wire (white/neutral) is connected to the center lower position of the terminal block.
- Tighten screws securely into the terminal block. DO not overtighten the screws.

### FOR CONDUIT INSTALLATION

- Loosen the 3 lower terminal screws on the terminal block. Strip wire to expose tip about 5/8" long.

- Insert the center (white/neutral) wire tip through the bottom center terminal block opening. On certain models, the wire will need to be inserted through the ground strap opening and then into the bottom center block opening. Insert the two side bare wire tips into the lower left and the lower right terminal block openings.

- Tighten the screws until the wire is firmly secured (35 to 50 inch-lbs.). Do not overtighten the screws.

**NOTE: Aluminum Wiring:** Aluminum building wire may be used but it must be rated for the correct amperage and voltage.

Power Cord

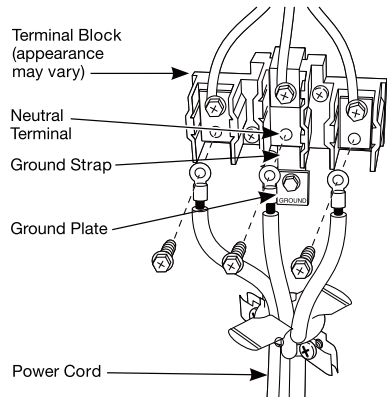

Conduit

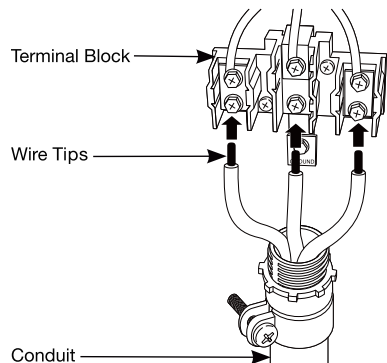







# 30" Standard Electric Range Installation Manual

Element, the Element Logo, and Bring it home are trademarks of Element Brand Holding, LLC. All other trademarks are the property of their respective owner, who has not sponsored, endorsed, or approved this product. ©2024 Element Appliance Company, LLC. All rights reserved.

Distributed by Element Appliance Company, LLC  
Augusta, GA 30909

For service, support and warranty information:  
Call 888.842.3577, email us at  
[customerservice@elementelectronics.com](mailto:customerservice@elementelectronics.com)  
or visit [www.elementelectronics.com](http://www.elementelectronics.com)

**EER34MSCW/EER34MSCS/EER34MSCB**