

element®

50 " UHD Digital LCD TV

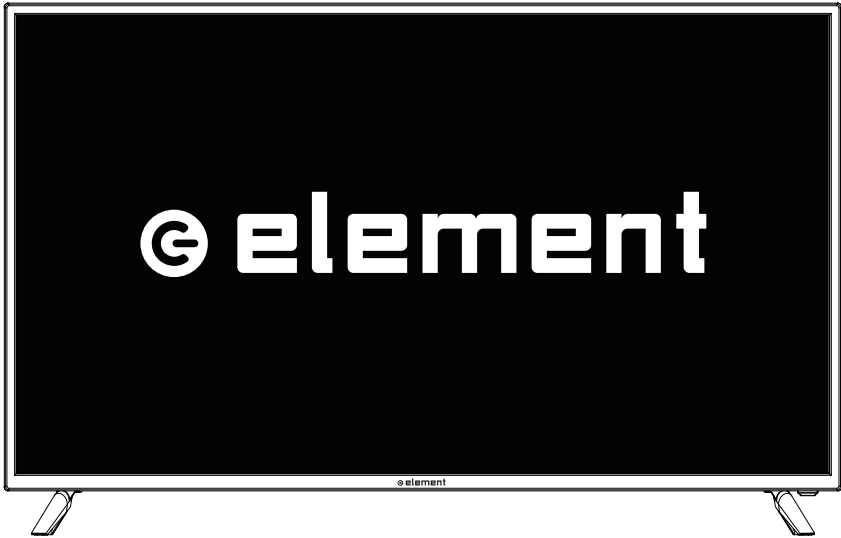

INSTRUCTION MANUAL

Please read all the instructions carefully before using this TV,
and keep the manual for future reference.

Important Safety Instructions	2
Additional Safety Information	3
Preparations	4
What is Included	4
Front View	5
Rear View	6
Wall Mounting	6
Remote Control	7
Connecting External Devices	9
Operating Your TV	10
Turning On/Off Your TV	10
Setup Wizard	10
Selecting The Input Source	11
Channel Selection	11
Volume Adjustment	11
Customizing TV Settings	12
Navigating the On-screen Display	12
Video Settings	13
Audio Settings	14
Time Settings	15
Setup Menu	16
Lock Settings	17
Parental Control	18
Channel Settings	20
USB Multimedia	21
Viewing Pictures	21
Viewing Videos	21
Troubleshooting	22
FCC Notes	25
Specifications	25
Warranty	26

IMPORTANT SAFETY INSTRUCTIONS

- **Read these instructions** – All the safety and operating instructions should be read before this product is operated.
- **Keep these instructions** – The safety and operating instructions should be retained for future reference.
- **Heed all warnings** – All warnings on the appliance and in the operating instructions should be adhered to.
- **Follow all instructions** – All operating and use instructions should be followed.
- **Do not use this apparatus near water** – The appliance should not be used near water or moisture – for example, in a wet basement or near a swimming pool, and the like.
- Clean only with dry cloth.
- **Do not block any ventilation openings.** Install in accordance with the manufacturer's instructions.
- **Do not** install near any heat sources such as radiators, heat registers, stoves, or other apparatus (including amplifiers) that produce heat.
- **Do not** defeat the safety purpose of the polarized or grounding-type plug. A polarized plug has two blades with one wider than the other. A grounding-type plug has two blades and a third grounding prong. The wide blade or the third prong are provided for your safety. If the provided plug does not fit into your outlet, consult an electrician for replacement of the obsolete outlet.
- Protect the power cord from being walked on or pinched particularly at plugs, convenience receptacles, and the point where they exit from the apparatus.
- Only use attachments/accessories specified by the manufacturer.
- Use only with the cart, stand, tripod, bracket, or table specified by the manufacturer, or sold with the apparatus. When a cart is used, use caution when moving the cart/apparatus combination to avoid injury from tip-over.



- Unplug this apparatus during lightning storms or when unused for long periods of time.

- Refer all servicing to qualified service personnel. Servicing is required when the apparatus has been damaged in any way, such as the power-supply cord or plug is damaged, liquid has been spilled or objects have fallen into the apparatus, the apparatus has been exposed to rain or moisture, does not operate normally, or has been dropped.
- Please keep the unit in a well-ventilated environment.

WARNING: To reduce the risk of fire or electric shock, do not expose this apparatus to rain or moisture. The apparatus should not be exposed to dripping or splashing. Objects filled with liquids, such as vases should not be placed on apparatus.

WARNING: The batteries shall not be exposed to excessive heat such as sunshine, fire or the like.

WARNING: The main plug is used as disconnect device, the disconnect device shall remain readily operable.

WARNING: To reduce the risk of electric shock, do not remove cover (or back) as there are no user-serviceable parts inside. Refer servicing to qualified personnel.



 This lightning flash with arrowhead symbol within an equilateral triangle is intended to alert the user to the presence of non-insulated "dangerous voltage" within the product's enclosure that may be of sufficient magnitude to constitute a risk of electric shock.

 The exclamation point within an equilateral triangle is intended to alert the user to the presence of important operating and maintenance instructions in the literature accompanying the appliance.

 This equipment is a Class II or double insulated electrical appliance. It has been designed in such a way that it does not require a safety connection to electrical earth.

HDMI[®]
HIGH-DEFINITION MULTIMEDIA INTERFACE
"HDMI, the HDMI logo and High-Definition Multimedia Interface are trademarks or registered trademarks of HDMI Licensing LLC."

ADDITIONAL SAFETY INFORMATION

To ensure reliable and safe operation of this equipment, please read carefully all the instructions in this user guide, especially the safety information below.

Electrical Safety

- The TV set should only be connected to a main power supply with voltage that matches the label at the rear of the product.
- To prevent overload, do not share the same power supply socket with too many other electronic components.
- Do not place any connecting wires where they may be stepped on or tripped over.
- Do not place heavy items on them, which may damage the leads.
- Hold the main plug, not the wires, when removing from a socket.
- During a thunderstorm, or when not using the television for extended period of time, turn off the power switch on the back of the television.
- Do not allow water or moisture to enter the TV or power adapter. Do NOT use in wet, moist areas, such as bathrooms, steamy kitchens or near swimming pools.
- Pull the plug out immediately, and seek professional help if the main plug or cable is damaged, liquid is spilled onto the set, if accidentally exposed to water or moisture, if anything accidentally penetrates the ventilation slots or if the set does not work normally.
- Do not remove the safety covers. There are no user serviceable parts inside. Trying to service the unit yourself is dangerous and may invalidate the product's warranty. Qualified personnel must only service this apparatus.
- To avoid battery leakage, remove exhausted batteries from the remote control, or when not using for long period.
- Do not break open or throw exhausted batteries on a fire.
- Do not mix old and new batteries.
- Do not mix Alkaline, Standard (Carbon-Zinc) or Rechargeable (Nickel Cadmium) or (Nickel Metal Hydride) batteries.

Physical Safety

- Do not block ventilation slots in the back cover. You may place the TV in a cabinet, but ensure at least 5cm (2") clearance all around.
- Do not tap or shake the TV screen, or you may damage the internal circuits. Take good care of the remote control.
- To clean the TV use a soft dry cloth. Do not use solvents or petroleum based fluids.
- Do not install near any heat sources such as radiators, heat registers, stoves or other apparatus (including amplifiers) that produce heat.
- Do not defeat the safety purpose of the polarized or grounding-type plug. A polarized plug has two blades with one wider than the other. A grounding type plug has two blades and a third grounding prong, the wide blade, or the third prong is provided for your safety. If the provided plug does not fit into your outlet, consult an electrician for replacement of the obsolete outlet.
- Protect the power cord from being walked on or pinched particularly at plugs.
- Unplug the apparatus during lightning storms or when unused for long periods.
- Refer all servicing to a qualified service personnel. Servicing is required when the apparatus has been damaged in any way, such as power-supply cord or plug is damaged, liquid has been spilled, or objects have fallen into the apparatus, has been exposed to rain or moisture, does not operate normally, or has been dropped.

PREPARATIONS

What is Included?

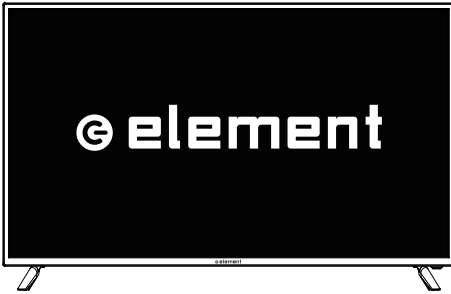

TV Set



Remote Control with Batteries

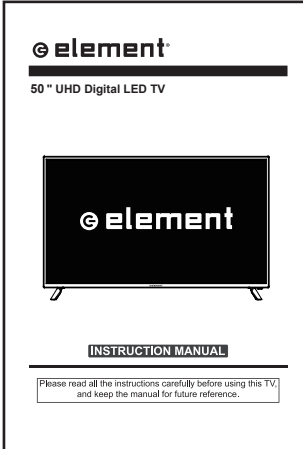

User Manual

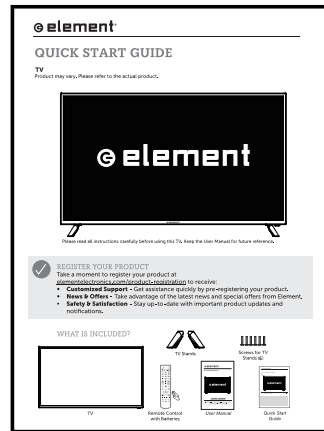

Quick Start Guide

PREPARATIONS

Front View

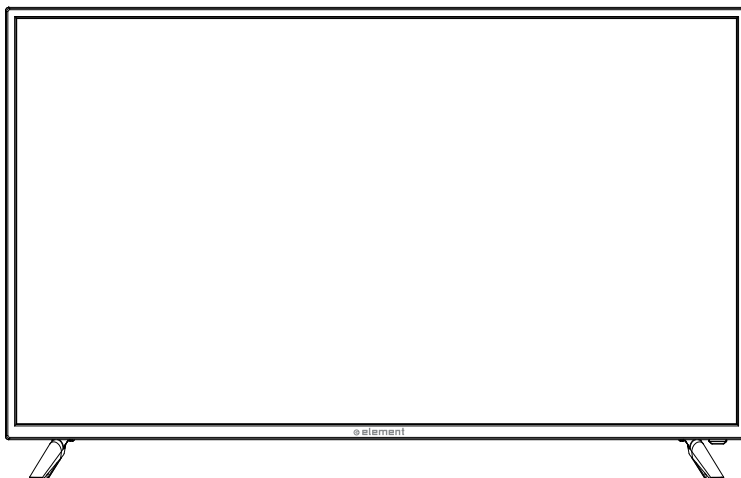

- **⏻**
Switch the TV between On / Standby mode.
- **INPUT**
Press to select among different input signal sources.
- **MENU**
Display the OSD (on screen display) menu.
- **CH -/+**
Press to select a channel.
- **VOL -/+**
Press to adjust the volume.
- **LED**
The LED light indicates when the TV is activated.
- **IR**
Infrared Receiver.

PREPARATIONS

Rear View

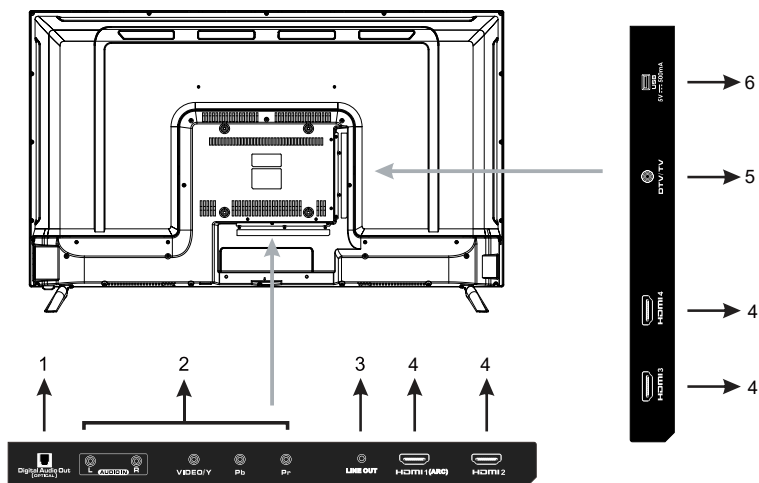

1. Optical output
2. COMPONENT/AV Input
3. LINE Output
4. HDMI Inputs
5. RF Input
6. USB Input

Wall Mounting

The TV is provided with mounting holes for a VESA approved wall mounting bracket (Not Supplied). Remove the screws holding the base to the base bracket and lift the base away (do not remove the base mounting brackets). Mount the VESA bracket using 4*M6*10 isometric threaded screws (Not Supplied).



Your new TV is heavy, please consult with professional wall mount installer to perform this installation.

PREPARATIONS

Remote Control

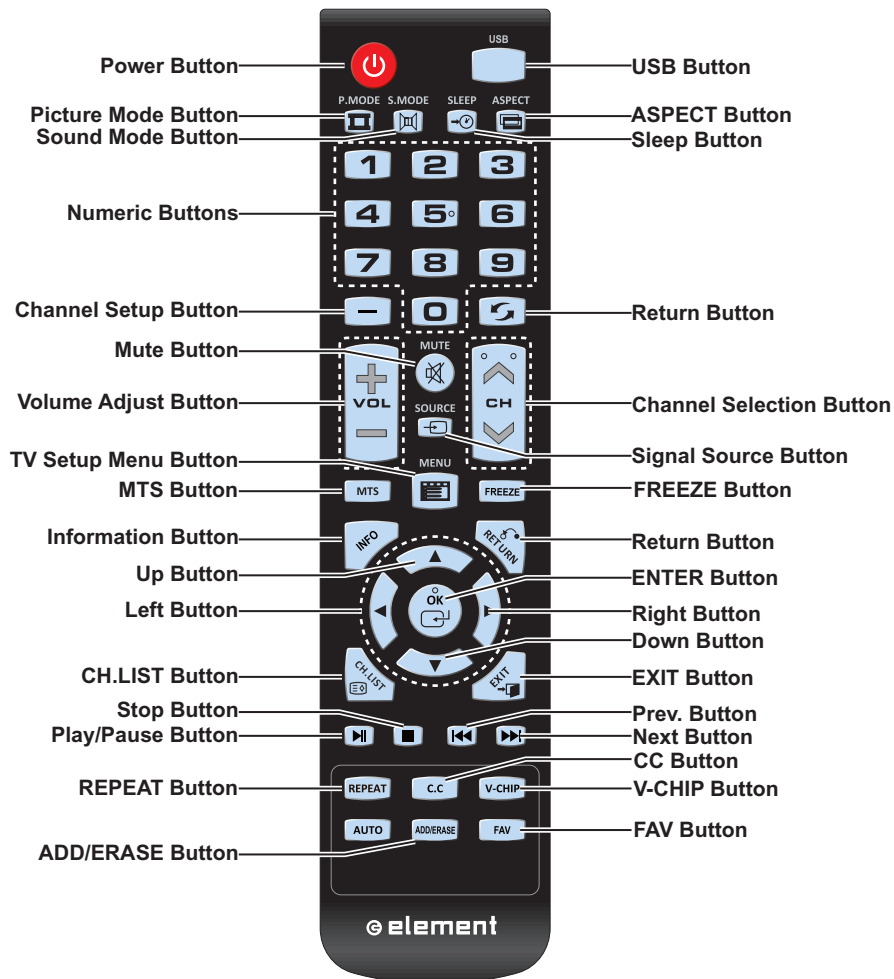







- If there is light around the TV, the remote control may fail or work abnormally.
- Please remove the batteries from the remote control when not in use for a long period time.
- Actual function for remote control keys prevails.
- To prevent battery leakage which may result in bodily injury or damage to the remote:

1. Install all batteries correctly, and as marked on the remote control.
2. Do not mix old and new batteries and do not mix alkaline, standard (carbon-zinc) or rechargeable (ni-cad, ni-mh, etc.) batteries.

PREPARATIONS

Remote Control

TV Operation	
	Switch the TV between on and standby mode.
USB	Access into the USB directly.
P.MODE	Select picture mode: Dynamic/Movie/Custom/Standard.
S.MODE	Select sound mode: Standard/Music/Movie/Sports/Custom.
SLEEP	Set the TV sleep timer: off/5/10.../180/240 min.
ASPECT	Select the aspect ratio settings:Normal/Wide/Zoom/Cinema.
0~9	Select a program (ATV/DTV mode)
—	Enter multiple program channel number , such as 2-1.
	Return to previous viewing channel.
VOL+/-	Adjust the volume.
CH ^ / v	Select a channel.
	Mute and restore your TV sound.
SOURCE	Select among the different input signal sources: TV/AV/Component/HDMI1/HDMI2/HDMI3/HDMI4/Media.
MENU	Display the OSD 'on screen display' menu.
MTS	Switch among different audio channels: STEREO/MONO/SAP.
FREEZE	Freeze the picture.
INFO	Display the present screen information such as the current channel and input source.
RETURN	Return to previous menu.
	Allows you to navigate the OSD menus and adjust the system settings to your preference.
OK	Confirm the selection in the OSD 'on screen display' menus.
CH.LIST	Display program list.
EXIT	Exit the OSD 'on screen display' menu.
CC	Closed Caption selection: Off/On/CC on Mute.
V-CHIP	Set up parental control.
ADD/ERASE	Add or delete Favorite channels.
FAV	Display the favorite channel list.

USB Operation	
	Press to pause or resume the playback.
	Press to stop the playback and clear the existing memory.
	Press to skip between chapters.
REPEAT	Press repeatedly to select the repeat mode.

CONNECTING EXTERNAL DEVICES

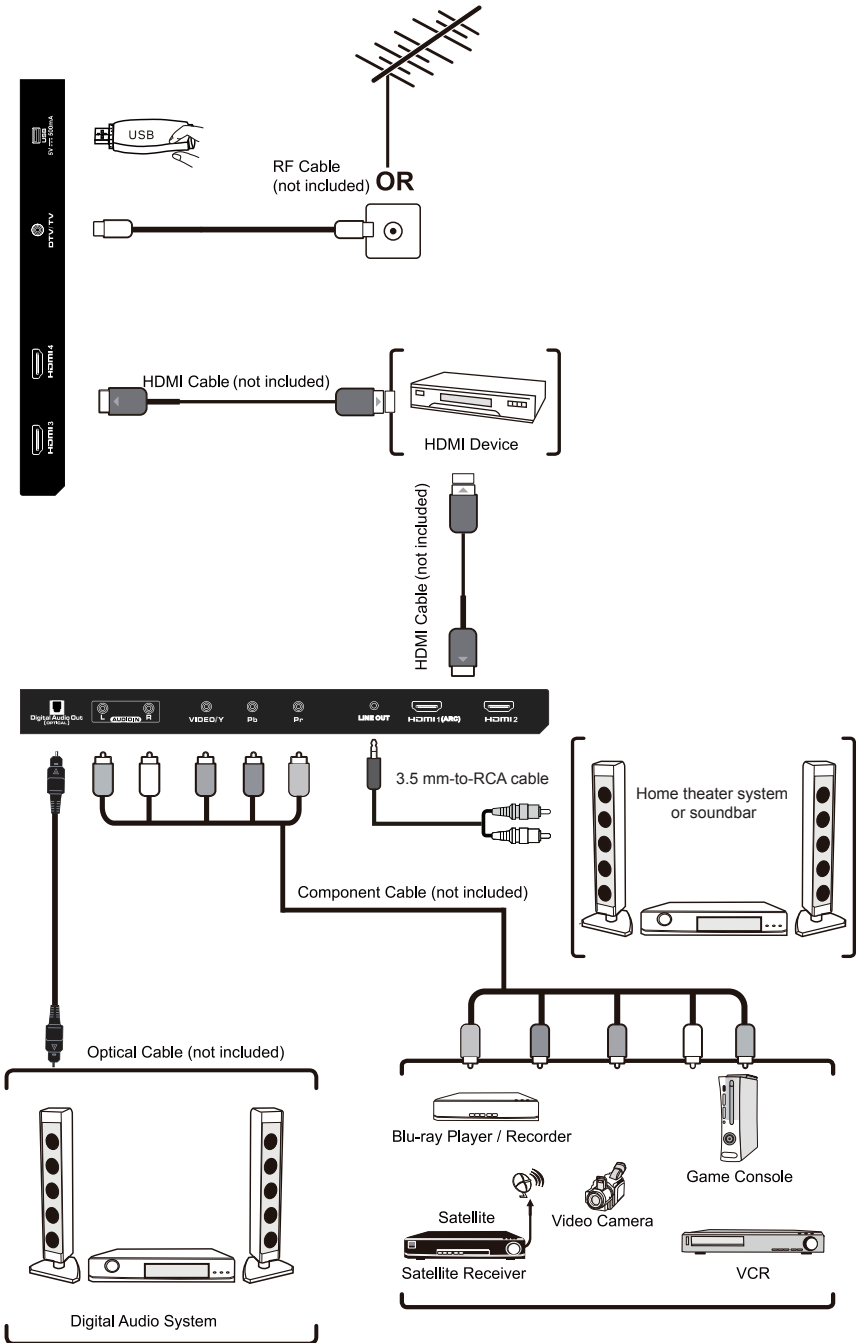

OPERATING YOUR TV





Turning On/Off Your TV

- Connect the power cord to the power socket after you have completed all the physical connections. At this stage, the TV will enter Standby Mode and the red LED indicator will illuminate.
- In Standby Mode, press the  button on the main unit or on the remote control to turn the TV on. The red LED indicator will turn off.



The **POWER** button on the main unit or on the remote control can only switch the TV into standby. To completely turn off the TV, please disconnect the power cord from the power socket.

Setup Wizard

- Press the  /  /  /  buttons to select your desired mode and press **OK** button to confirm.



Menu Language	Select your desired language to be displayed on the menu. The default on-screen menu language is set as English.
Time	Select the time zone and daylight saving time.
Air/Cable	Select antenna between Air and Cable.
Auto Scan	Search and store the available channels automatically.

OPERATING YOUR TV

Selecting The Input Source

- Press the **SOURCE** button on the main unit or on the remote control to display the Input Source list.
- Press the **▲/▼** buttons to select your desired input source among: TV/Component /AV/HDMI / Media and then press **OK** button to confirm.

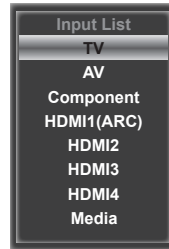

Channel Selection

- Press the **CH[^]/CH^v** buttons on the main unit or on the remote control repeatedly to select the channel.
- Press the **0-9** buttons on the remote control to select the channel directly.



Press "4", and then press **OK** button to select channel 4.
Press "4" and "5", and then press **OK** button to select channel 45.

Volume Adjustment

- Press the **VOL+/-** buttons on the main unit or on the remote control to adjust the volume.
- If you wish to switch the sound off, press the **MUTE** button again or the **VOL+** button to resume the sound.

CUSTOMIZING TV SETTINGS

Navigating the On-screen Display

- Press the **MENU** button to display the main menu.
- Press the **◀/▶** buttons to navigate and select the available menus.

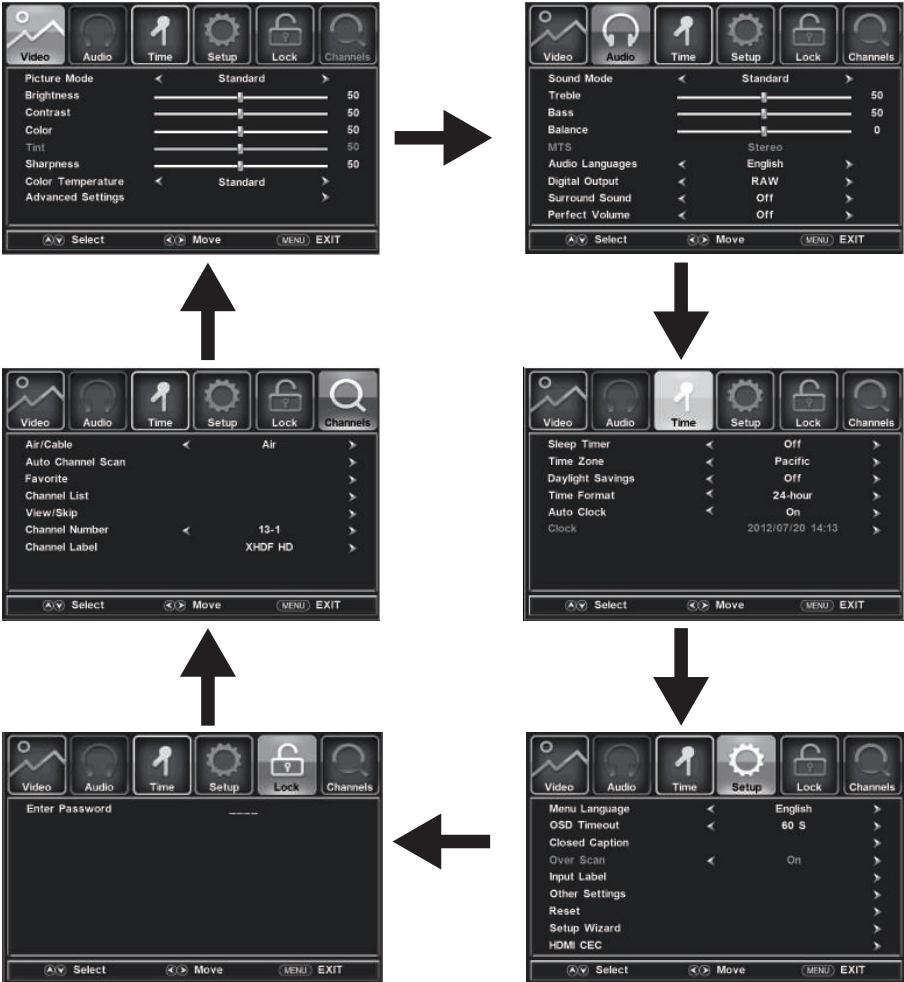

CUSTOMIZING TV SETTINGS

Video Settings

- Press the **MENU** button on the main unit or on the remote control then press the ◀/▶ buttons to select **Video** menu and then press the ▼ or the **OK** button to enter.
- Press the ▲/▼ buttons to select the following video options and then press the ◀/▶ buttons to adjust each option's setting.

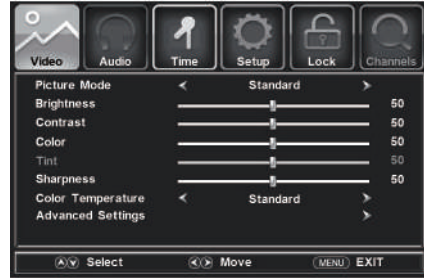



Picture Mode	Cycle among picture modes: Standard/ Movie / Custom /Dynamic.  Alternative: you may press the P.MODE button to select the picture mode directly.
Brightness	Increase or decrease the amount of white in the picture. <i>(For Custom cmode)</i>
Contrast	Adjust the difference between light and dark levels in the pictures. <i>(For Custom mode)</i>
Color	Control the color intensity. <i>(For Custom mode)</i>
Tint	Adjust the balance between red and green levels.
Sharpness	Adjust the level of crispness in the edges between light and dark areas of the picture. <i>(For Custom mode)</i>
Color Temperature	Cycle among color temperature: Standard/Warm/Cool.
Advanced Settings	Adjust Aspect , noise reduction and dynamic contrast HDMI mode.

CUSTOMIZING TV SETTINGS

Audio Settings

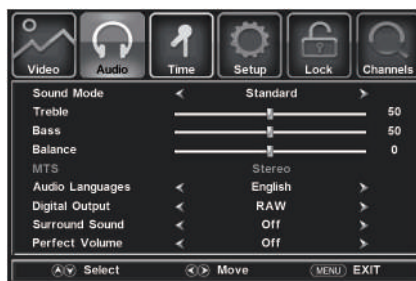
- Press the **MENU** button on the main unit or on the remote control then press the ◀/▶ buttons to select **Audio** menu and then press the ▼ or the **OK** button to enter.
- Press the ▲/▼ buttons to select the following audio options and then press the ◀/▶ buttons to adjust each option's setting.



Sound Mode	<p>Allow the selection of an audio-enhancement technique: Standard/Music/Movie/Sports/Custom.</p> <p> Alternative: You may press the S.MODE button to select the sound mode directly.</p>
Treble	Control the relative intensity of higher-pitched sounds. <i>(For Custom mode)</i>
Bass	Control the relative intensity of lower-pitched sounds. <i>(For Custom mode)</i>
Balance	Adjust the audio output between the left and the right speakers.
MTS	Select the analog audio output mode: Mono, Stereo, and SAP.
Audio Languages	Select audio language among: English, French, Spanish.
Digital Output	Select the digital audio output mode between RAW/PCM.
Surround Sound	Provide an enhanced listening experience.
Perfect Volume	Volume levels are automatically controlled to keep at the same level when switch channels.
TV Speaker	Set on/off the TV speaker.

CUSTOMIZING TV SETTINGS

Time Settings

- Press the **MENU** button on the main unit or on the remote control then press the ◀/▶ buttons to select **Time** menu and then press the ▼ or the **OK** button to enter.
- Press the ▲/▼ buttons to select the following time options and then press the ◀/▶ button to adjust each option's setting.



Sleep Timer	Select a period of time after which the TV automatically switches to standby mode: off, 5min, 10min, 15min, 30min, 60min, 90min, 120min, 180min, or 240min.
Time Zone	Select a Time Zone among: Pacific/Alaska/Hawaii/Atlantic/ Eastern/Central / Mountain.
Daylight Saving Time	Select to turn On/Off daylight saving time.
Time Format	Adjust time format, 24 hours, 12 hours.
Auto Clock	Set the Auto Clock on or off.
Clock	Set the clock manually when Auto Clock is set to off.

CUSTOMIZING TV SETTINGS

Setup Menu

- Press the **MENU** button on the main unit or on the remote control then press the ◀/▶ buttons to select **Setup** menu and then press the ▼ or the **OK** button to enter.
- Press the ▲/▼ buttons to select the following setup options and then press the ◀/▶ buttons to adjust each option's setting.



Menu Language	Select menu language among: English, Français or Español. The default on-screen menu language is English.	
OSD Timeout	Select and adjust the menu closing time 5s, 15s, 30s, 45s, 60s.	
Closed Caption	CC Mode	Select CC mode among: CC On, or CC off, CC on Mute.
	Analog cc	Select analog mode among: CC1, CC2, CC3, CC4, Text1, Text2, Text3, Text4.
	Digital cc	Select digital mode among: Service1~6.
	Option	Personalize the captioning style, such as the size and color of the digital caption.
Over Scan	Set on/off Overscanning of Digital TV.	
Input Label	Edit the input source name.	
Other Settings	Audio Only	Turn off the TV screen and listen to the audio only.
	Demo Mode	Select demo mode for retail promotion use Á with higher contrast, brightness, and color Á settings.
	HDMI 4K	Turn off the HDMI 4K when the connected device is not support 4K signal to avoid the distorted picture.
Reset	Restore the TV to factory default settings. (Except the lock settings)	
Setup Wizard	Readjust basic TV data, language, Time Zone, Á Daylight Savings, Time Format, Channel.	
HDMI CEC	When this element is activated, CEC can be used.	
Voice Guidance	Select to turn voice guidance on or off. When the voice guidance is on, you can adjust the Volume, Speed, and Á Pitch.	
Video Description	Video description, ON OFF.	

CUSTOMIZING TV SETTINGS

Lock Settings

- Press the **MENU** button on the main unit or on the remote control and then press the ◀/▶ buttons to select **Lock** menu.
- Use the **0-9** buttons to input 4-digit password to enter the **Lock** menu.
- Press the ▲/▼ buttons to select the following options and then press the ◀/▶ buttons to adjust each option's setting.



Input 4-digit password



The default password is "0000".

Change Password	Use 0-9 buttons to input the old password and then input the new 4-digit password. Re-enter new password for confirmation.		
KeyPad Lock	Turn on and lock the TV button.		
Parental Lock	Select to turn the parental control on or off. The following options (Input Block, US Rating, and Canada Rating) will only be accessible when you turn the parental control on.		
Input Block	Select to lock specific input source.		
US Rating	TV	TV RATING: Press OK button to lock or unlock TV rating.	
	MPAA	Select MPAA rating among: Off, G, PG, PG-13, R, NC-17, or X.	
Canada Rating	Canada English	Select MPAA rating for English-speaking Canada among: Off, C, C8+, G, PG, 14+, 18+.	
	Canada French	Select MPAA rating for Quebec Canada among: Off, G, 8 ans+, 13 ans+, 16 ans+, 18 ans+.	
Region 5	Set the Rating Region Table.		
Reset Region 5	Select to reset the Region 5 setting.		

CUSTOMIZING TV SETTINGS

Parental Control

Press the **MENU** button on the main unit or on the remote control and then press the **◀/▶** buttons to select **LOCK** menu. Use the **0-9** buttons to input 4-digit password to enter the **LOCK** menu. If used, this option feature can "block" undesirable programming from appearing on the TV. Parental Control offers the user a wide variety of options and settings that restrict or "block" the programming that can appear on the TV. Parental Control allows the user the capability of defining which program rating they consider acceptable to the younger more sensitive viewer. It can be preset and turned either on or off by the user who specifies the secret 4-number code, the password. The number of hours blocked are specified. General audiences and children blocks should be both programmed into the TV's memory. Viewer ratings are specified for both TV and the motion picture Industry; both rating systems should be used, for complete coverage. The ratings are based on the ages of children.

Overview

To ensure complete coverage for all TV programs, (movies and regular TV shows) choose a rating for MPAA, from the selections below, as well as ratings from the TV Parental Guidelines Rating Systems below, using the Age Block option for General Audiences, and for children. In addition to those, you may wish to add additional restrictions from the content block menu, and submenus examples below.

Things to Consider before Setting up Parental Control

Determine which rating you consider acceptable to the viewer. (For example, if you choose TV-PG, more restrictive ratings will be automatically blocked; the viewer will not be able to see: TV-PG, TV-14, or TV-MA rated programming.) Do you want to block the auxiliary video source entirely? (Blocks the signal sent by the equipment, such as VCR, connected to the TV Audio/Video Input Jacks) Or leave unblocked, then choose allowable ratings. Block program "Content" based on individual parameters such as: Strong Dialog, Bad Language, Sex Scenes, Violence Scenes, or Fantasy. Violent Scenes; in Content Blk option. Select a secret password, in the Set Password option, using the numbers keys on the remote control. Do not forget the password, it is the only way you can access the Parental Control menu and change rating selections, or turn Parental Control off. Do you want the Parental Control to be active at all times? If not, you can turn it on or off with the Lock On/Off option.

- You can set different Parental Control viewing restrictions for general audiences and for children, both can be active at the same time.
- Simply specifying one content block such as Sex Scenes, will not automatically restrict the programming that appears from the video sources.
- Even if you choose to leave the AUX Inputs unblocked, the ratings you specify will automatically restrict the programming that appears from the video sources.
- You can not disable Parental Control by disconnecting the TV from power. Block hours will be automatically reset to the original block time setting specified if power is disconnected.

CUSTOMIZING TV SETTINGS

Motion Picture Association of America (MPAA) Rating System

	Grade	Meaning
G	General Audiences	Content not offensive to most viewers.
PG	Parental Guidance Suggested	Content is such that parents may not want their children to view the program.
PG-13	Parents Strongly Cautioned	Program is inappropriate for pre-teens, with a greater degree of offensive material suggested than a PG rated program.
R	Restricted	Not for children under 17, strong element of sex and/or violence.
NC-17	No children under age 17	Not for children under 17 under any circumstances. Strong sexual content.
X	Hard Core Films	Same as NC-17 rating.
No Rating		MPAA Not Rated.

TV Parental Guideline Rating System

	Grade	Meaning
TV-Y	All Children	Content not offensive to most viewers.
TV-Y7	Directed to Older Children	Considered suitable for children over 7, may contain fantasy violence scenes.
TV-G	General Audience	Considered suitable for all audience; children may watch unattended.
TV-PG	Parental Guidance Suggested	Suggested unsuitable for younger children, may contain suggestive language, bad language, sex and violence scenes.
TV-14	Parents Strongly Cautioned	unsuitable for children under 14, may contain strong language, bad language, sex and violence scenes.
TV-MA	Mature Audience Only	Adults only, may contain strong language, bad language, sex and violence scenes.

Canadian Rating:

- *Canadian English is used throughout all English-speaking Canada (C, C8+,G, PG,14+, 18+).*
- *Canadian French is used in Quebec (G,8 ans+, 13 ans+,16 ans+, 18 ans+).*





The V-Chip will automatically block certain categories that are "more restrictive". If you block TV-Y category, then TV-Y7 will be automatically blocked. Similarly, if you block TV-G category, then all the categories in the "young adult" will be blocked (TV-G, TV-PG, TV-14, and TV-MA).

CUSTOMIZING TV SETTINGS

Channel Settings

- Press the **MENU** button on the main unit or on the remote control and then press the ◀/▶ buttons to select **Channel** menu.
- Press ▲/▼ buttons to select the following channel options and then press the ◀/▶ buttons to adjust each option's setting.
- Channels can only be used in TV mode



Air/Cable	Select antenna between Air and Cable.
Auto Channel Scan	<ul style="list-style-type: none"> • Search and store all available channels automatically. • Enter the automatic scanning interface, select confirm scanning, and then enter the next interface. • Then they scan the program, and when they're done they can watch it. <div style="display: flex; justify-content: space-around; align-items: center;">   </div>
Favorite	<ul style="list-style-type: none"> • Set the selected channel as one of the favorite programs. <div style="text-align: right;">  </div>
Channel List	Open the channel list.
View/Skip	Show/Hide the selected channel.
Channel Number	Display the current channel number.
Channel Label	Display the current channel label.

USB MULTIMEDIA

Viewing Pictures

- Press the **SOURCE** button on the main unit or on the remote control then press the **▲/▼** buttons to select the **Media** mode and then press **OK** button.
- Press the **◀/▶** buttons to select **Photo** and then press **OK** button.



File format supported: JPEG.

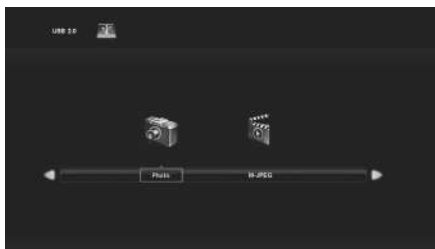

Viewing Video

- Press the **SOURCE** button on the main unit or on the remote control then press the **▲/▼** buttons to select the **Media** mode and then press **OK** button.
- Press the **◀/▶** buttons to select **M-JPEG** and then press **OK** button.



File format supported: M-JPEG.

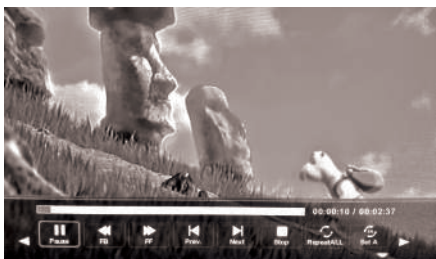

Operation Tips

	Press to start or pause the photo/video playback.
	Press to stop photo/video playback.
	Press to play the previous track or view the previous photo/video
	Press to play the next track or view the next photo/video
REPEAT	Press to select different repeat mode.

TROUBLESHOOTING

If your TV does not operate normally or cannot be turned on, please check the following troubleshooting questions. Remember also to check any other connected electronic device, such as DVD or blu-ray player to pinpoint the problem. If the TV still fails to operate normally, please contact technical support (Refer to Warranty page).

SYMPTOM	POSSIBLE CAUSE	REMEDY
Dead. No LED lit	No power to the TV.	<ul style="list-style-type: none">• Check all connections to the TV's AC socket.
Dead. No LED lit red	Set in standby mode.	<ul style="list-style-type: none">• Press either the Power button or the Standby button on the remote control.
Blue screen	No signal.	<ul style="list-style-type: none">• Press the SOURCE button to select the correct source.
	Incorrect source selected.	
Noisy, snowy, ghosting picture (TV)	Poor antenna signal.	<ul style="list-style-type: none">• If using an indoor antenna, try adjusting the antenna position. Check antenna connections.
No sound	Sound "Mute".	<ul style="list-style-type: none">• Turn sound "Mute" off.
	Volume set too low.	<ul style="list-style-type: none">• Check volume settings.
	External leads not connected "if used".	<ul style="list-style-type: none">• Check that all external leads are connected properly.

TROUBLESHOOTING

Before contacting the service technician, perform the following simple checks. If any problem still persists, unplug the LED TV and call for assistance.

PROBLEM	POSSIBLE SOLUTIONS
No sound and picture	<ul style="list-style-type: none"> • Check that the main plug has been connected to a wall outlet. • Check that you have pressed the POWER on the front of the TV set. • Check the picture contrast and the brightness setting.
Red LED indicator lights	<ul style="list-style-type: none"> • Set in standby mode. Press either the Power button or the Standby button on the remote control.
Normal picture but no sound	<ul style="list-style-type: none"> • Check the volume. • Sound muted? Press the MUTE button. • Try another channel, the problem may be with the broadcast. • Are the audio cables installed properly?
The remote control does not work	<ul style="list-style-type: none"> • Check to see if there are any objects between the TV and remote control causing obstruction. • Are batteries installed with correct polarity (+/-)? • Correct remote operating mode set: TV, VCR, etc? • Install new batteries.
Power suddenly turns off	<ul style="list-style-type: none"> • Is the sleep timer set? • Check the power connection, power may be interrupted. • No broadcast on the station tuned.
Picture appears slowly after switching on	<ul style="list-style-type: none"> • This is normal, the image is muted during the product start up process. Please contact a service provider if the picture has not appeared after 5 minutes.
Poor color or picture	<ul style="list-style-type: none"> • Adjust the color in Menu option. • Keep a sufficient distance between the product and the VCR. • Try another channel, the problem may be with the broadcast. • Are the VIDEO cables installed properly? • Activate any function to restore the brightness of the picture.
Horizontal/vertical bars or picture shaking	<ul style="list-style-type: none"> • Check for local interference, such as an electrical appliance or power tool.
Blue screen	<ul style="list-style-type: none"> • Press the SOURCE button to select correct source.
Poor reception on some channels	<ul style="list-style-type: none"> • Station or cable experiencing problems. Tune to another station. • Station signal is weak, reorient antenna for better reception. • Check for sources of possible interference.
Lines or streaks in pictures	<ul style="list-style-type: none"> • Check the antenna (change the direction of the antenna).
No output from one of the speakers	<ul style="list-style-type: none"> • Adjust balance in the Menu option.

TROUBLESHOOTING

Note: When there is a problem in VGA mode (only when VGA mode is applied).

PROBLEM	POSSIBLE SOLUTIONS
The signal is out of range	<ul style="list-style-type: none">• Adjust resolution, horizontal or vertical frequency.• Check whether the signal cable is connected or loose.• Check the input source.
Vertical bar or strip on the background, horizontal noise and incorrect position	<ul style="list-style-type: none">• Set the auto configure or adjust clock, phase, or H/V position.
Screen color is unstable or is a single color	<ul style="list-style-type: none">• Check the signal cable.• Reinstall the PC video card.

Maintenance

Early malfunction can be prevented. Careful and regular cleaning can extend the amount of time you will have with your new TV. Be sure to turn the power off and unplug the power cord before you begin any cleaning.

Do not use your TV in areas that are too hot or too cold, because the cabinet may warp or the screen may malfunction. Your TV works best in temperatures that are comfortable to you.

Storage temperatures are 32° to 122°F(0° to 50°C).

Working temperatures are 32° to 95°F(0° to 35°C).

Do not place your TV in direct sunlight or near a heat source.

-minimum 5cm distances around the apparatus for sufficient ventilation;

-the ventilation should not be impeded by covering the ventilation openings with items, such as newspapers, table-cloths, curtains, etc.;

-no naked flame sources, such as lighted candles, should be placed on the apparatus;

-attention should be drawn to the environmental aspects of battery disposal.

Clean the screen

A great tip to dust off your screen: wet a soft cloth in a mixture of lukewarm water and a little fabric softener or dish washing detergent. Wring the cloth until it's almost dry, and then use to wipe the screen.

Make sure the excess water is off the screen, then let air-dry before you turn on the TV.

Cleaning the cabinet

To remove dirt or dust, wipe the cabinet with a soft, dry, line-free cloth. Please be sure not to use a wet cloth.



- "Warning: Changes or modifications to this unit not expressly approved by the party responsible for compliance could void the user's authority to operate the equipment."

- "NOTE: This equipment has been tested and found to comply with the limits for a Class B digital device, pursuant to Part 15 of the FCC Rules. These limits are designed to provide reasonable protection against harmful interference in a residential installation. This equipment generates, uses and can radiate radio frequency energy and, if not installed and used in accordance with the instructions, may cause harmful interference to radio communications.

However, there is no guarantee that interference will not occur in a particular installation. If this equipment does cause harmful interference to radio or television reception, which can be determined by turning the equipment off and on, the user is encouraged to try to correct the interference by one or more of the following measures:

- Reorient or relocate the receiving antenna.
- Increase the separation between the equipment and receiver.
- Connect the equipment into an outlet on a circuit different from that to which the receiver is connected.
- Consult the dealer or an experienced radio/TV technician for help."

Please send all correspondence to:
Element TV Company, LP. Customer Service
1-888-842-3577
www.elementelectronics.com
customerservice@elementelectronics.com

SPECIFICATIONS

Model name	E4AA50N
Panel Size	49.5 inches diagonally
Display Type	LCD
Panel Technology	TFT
Panel60HzVs.120Hz	60Hz
Display Resolution	3840x2160
HDMI Support	Up to 4K
Panel Resolution	3840x2160
Aspect Ratio	16:9
Dynamic Contrast Ratio-Panel	5000:1
Brightness(Centre Typ.)Cd/M ²	220-250
ResponseTime(G To G)	8 ms
LampLife(Typ.Hours)	>30000 hours
HorizontalViewing Angle(AtCR>20)	170
VerticalViewing Angle(AtCR>20)	170
TV System	ATSC/NTSC
Channel Range	Air CH2~CH69 / Cable CH1~CH135

Design and specifications are subjects to change without prior notice.

WARRANTY

ELEMENT LCD TV LIMITED WARRANTY TO ORIGINAL CONSUMER

LCD TV– 42 inches and above Screen Size Models (the “Product”)

This Product (including any accessories included in the original packaging) as supplied and distributed in new condition, is warranted by Element TV Company, LP (“Element”) to the original purchaser against defects in material and workmanship (“Warranty”) as follows:

1. WARRANTY SERVICE (Parts, Labor and/or Replacement): For a period of **one (1) year** from the date of the original customer purchase (“the Warranty Period”), if this Product or any of its parts are determined by Element or an Element authorized customer service provider to be defective in material or workmanship, Element will, at its sole discretion and option: (i) supply, at no charge to the original customer, new or rebuilt replacement parts in exchange for defective parts, (ii) repair the Product and pay the labor charges of such Element authorized service provider for same, at no charge to the original customer, (iii) replace the Product with a new or refurbished product of similar or better quality, at no charge to the original customer, or (iv) refund the original purchase price of the Product (excluding tax) to the original customer. After the Warranty Period, the customer must pay for all parts, labor and replacement costs associated with the Product, regardless of any defects in the Product.

A. IN-HOME SERVICE: During the Warranty Period, this Warranty includes “in-home” service (subject to availability), which includes an Element authorized service provider repairing the Product in the original customer’s home, or taking the Product for repairs at an Element authorized service provider and returning the Product to the original consumer’s home. “In-home” service is NOT available in all areas. In order for a customer to receive “in-home” service, the Product must be accessible to the Element authorized service provider. If “in-home” service is unavailable, or the repair cannot be completed through “in-home” service, Element may require that the customer transport the Product to an Element authorized service center, for which the customer may be responsible for any transportation charges incurred to deliver the Product or part(s) to an Element authorized service provider for diagnosis, repair or replacement. The customer shall not return the Product to Element without Element’s prior written consent. Element recommends that the customer insure the Product for its full replacement cost when shipping.

B. TIMING AND PROCEDURE: Before Warranty service can commence, the original customer purchaser must contact Element for problem determination and service procedures. Proof of purchase in the form of a bill of sale or receipted invoice, evidencing that the Product is within the Warranty Period, MUST be presented to an Element authorized customer service provider in order to obtain the requested service. Please call the Toll Free Customer Service Line at (888) 842-3577 to obtain Warranty Service and Troubleshooting information. Please have your model and serial number available, along with your date of purchase of the Product. You can also visit us online at: www.elementelectronics.com.

2. EXCLUSIONS AND LIMITATIONS TO WARRANTY SERVICE

This Warranty covers manufacturing defects in materials and workmanship encountered in the normal, non-commercial use of the Product, and does not cover (a) damage or failure caused by or attributable to Product abuse or misuse, failure to follow instructions, improper installation or maintenance, alteration, accident, or excess voltage or current; (b) improper or incorrectly performed repairs by non-authorized service facilities; (c) onsite customer instruction or adjustments; (d) transportation, shipping, delivery, insurance, installation or set-up costs; (e) costs of product removal, transportation or reinstallation costs; (f) ordinary wear and tear, cosmetic damage or damage due to acts of nature, including but not limited to water, floods, wind, tornado,

WARRANTY

earthquake or fire, or due to damage caused by automobile accidents or extraordinary impact events, such as dropping or crushing; (g) commercial use of the Product; (h) modification of the Product or to any part of the Product. In addition, this Warranty does not cover images “burnt” into the screen.

This Warranty applies to the original consumer only and does not cover Products sold AS IS or WITH ALL FAULTS, or consumables (e.g., fuses, batteries, bulbs etc.). The Warranty is invalid if the factory-applied serial number has been altered or removed from the Product. This Warranty is valid only in the United States and Canada, and only applies to products purchased and serviced in the United States and Canada. All replaced parts and Products, and Products on which a refund is made, become the property of Element. The addition of equipment or features to the Product that are not manufactured or recommended by Element could affect the intended function of the Product, and therefore may void the Warranty. The Warranty is contingent upon the proper use, maintenance and care of the Product. The Warranty may be void if the Product has been used in a manner contradictory to or in violation of the terms of the user's manual, warnings or instructions accompanying the Product.

This Warranty is made in lieu of and supersedes all other warranties or conditions of merchantability or fitness for a particular purpose or general use, whether express, implied, collateral, statutory, or provided by common law, the Uniform Commercial Code or otherwise. Element further disclaims all warranties after the end of the Warranty Period defined above. No other express warranty or guaranty given by any other person, firm or entity with respect to the Product shall be binding on Element. Repair, replacement, or refund of the original purchase price, at Element's sole discretion, are the exclusive remedies of the customer. Element shall not be liable for any incidental or consequential damages caused by the use, misuse or inability to use the Product. These include but are not limited to any damages in the form of lost profits, loss of use, legal fees, economic loss, personal injuries, or any other damages caused by circumstances beyond the control of Element. Notwithstanding the foregoing, the customer's recovery shall not exceed the purchase price of the Product. This Warranty shall not extend to anyone other than the original customer who purchased the Product, and is not transferrable. No person is authorized to alter, extend or waive the Warranty of Element.

Some states do not allow the exclusion or limitation of incidental or consequential damages, or allow limitations on warranties, so the above limitations or exclusions may not apply to you. This Warranty gives you specific rights, and you may have other rights, which vary from state to state. The exclusions and limitations to the Warranty apply to the maximum extent permitted by law and unless restricted or prohibited by law. Where any term of this Warranty is prohibited by applicable law, it shall be null and void, but the remainder of this Warranty shall remain in effect.

PLEASE DIRECT ALL CORRESPONDENCE TO:

Element TV Company, LP Customer Service

customerservice@elementelectronics.com

(888) 842-3577

www.elementelectronics.com

PLEASE CONTACT CUSTOMER SERVICE TO CONFIRM ADDRESSES AND PROCEDURES FOR WARRANTY SERVICE.

v: 201807



This product contains electrical or electronic materials. The presence of these materials may, if not disposed of properly, have potential adverse effects on the environment and human health. Presence of this label on the product means it should not be disposed of as unsorted waste and must be collected separately. As a consumer, you are responsible for ensuring that this product is disposed of properly.