

# USER MANUAL

## 17.6 CU. FT. REFRIGERATOR

ENR18TFGCW | ENR18TFGCB | ENR18TFGCS

Product may vary. Please refer to the actual product.

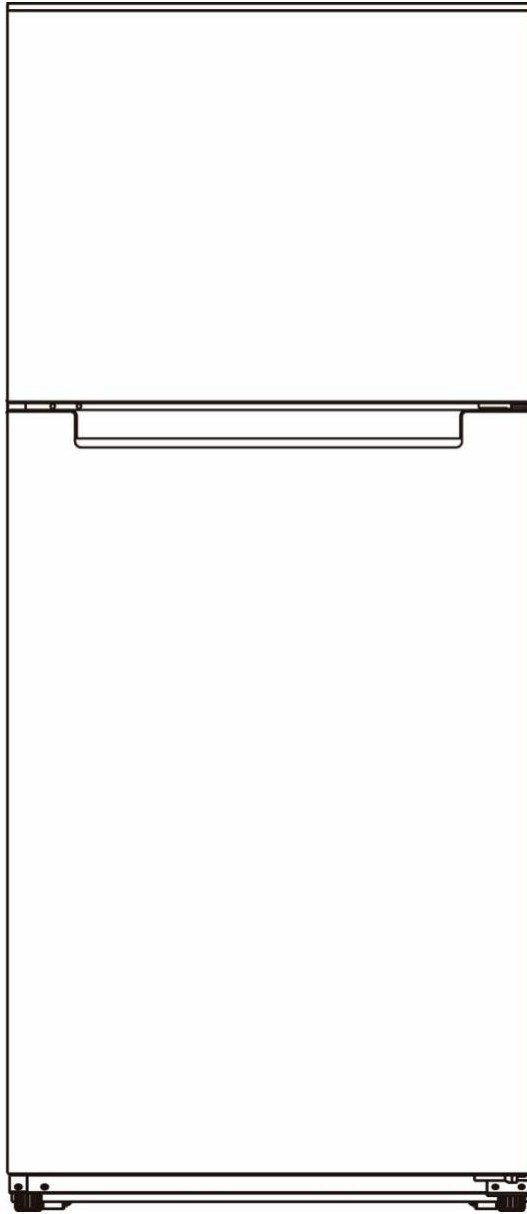



# CONTENTS

REGISTER YOUR REFRIGERATOR.....	3
GETTING TO KNOW YOUR REFRIGERATOR.....	3
WHAT IS INCLUDED? .....	3
INSIDE VIEW.....	4
TEMPERATURE CONTROLS.....	4
SETTING UP YOUR REFRIGERATOR .....	5
REVERSING THE DOORS.....	5
POSITIONING YOUR REFRIGERATOR .....	8
ADJUSTING STORAGE ACCESSORIES.....	10
TURNING ON YOUR REFRIGERATOR.....	10
USING YOUR REFRIGERATOR .....	10
ADJUSTING THE TEMPERATURE .....	11
STORING FOOD .....	11
NAVIGATING POWER OUTAGES .....	12
SAVING ENERGY.....	12
MAINTAINING YOUR REFRIGERATOR .....	13
CLEANING AND CARE.....	13
REPLACING THE LIGHT.....	13
MOVING YOUR REFRIGERATOR.....	13
PREPARING FOR LONG-TERM STORAGE .....	14
SERVICING YOUR REFRIGERATOR.....	14
SAFETY AND PRECAUTIONS .....	14
SPECIFICATIONS .....	16
TROUBLESHOOTING.....	17
CUSTOMER SUPPORT.....	18
LEGAL NOTICES .....	19
WARRANTY .....	19

## REGISTER YOUR REFRIGERATOR

Thank you for purchasing the Element 17.6 cu. ft. Refrigerator. If you have questions about your refrigerator, our customer support team is ready to help:

- **Online chat:** [www.elementelectronics.com](http://www.elementelectronics.com)
- **Phone:** 1 (888) 250-6588
- **Email:** [appliance@elementelectronics.com](mailto:appliance@elementelectronics.com)

To register your refrigerator, go to <https://elementelectronics.com/registration/>, fill out the Product Registration form, then upload a picture of your receipt. Your serial number is located inside your refrigerator.

Use the space below to record information about your refrigerator and keep your original purchase receipt for future reference. You'll need this information to receive warranty service.



17.6 cu. ft. Refrigerator

**Model Number:** \_\_\_\_\_

**Serial Number:** \_\_\_\_\_  
(located below the rating label inside your refrigerator)

**Date of Purchase:** \_\_\_\_\_

Keep this information and  
your original purchase receipt  
to receive warranty service.

## GETTING TO KNOW YOUR REFRIGERATOR

### WHAT IS INCLUDED?

- 17.6 cu. ft. Refrigerator
- Spare parts bag (for door reversal)
- *User Manual*

**INSIDE VIEW**

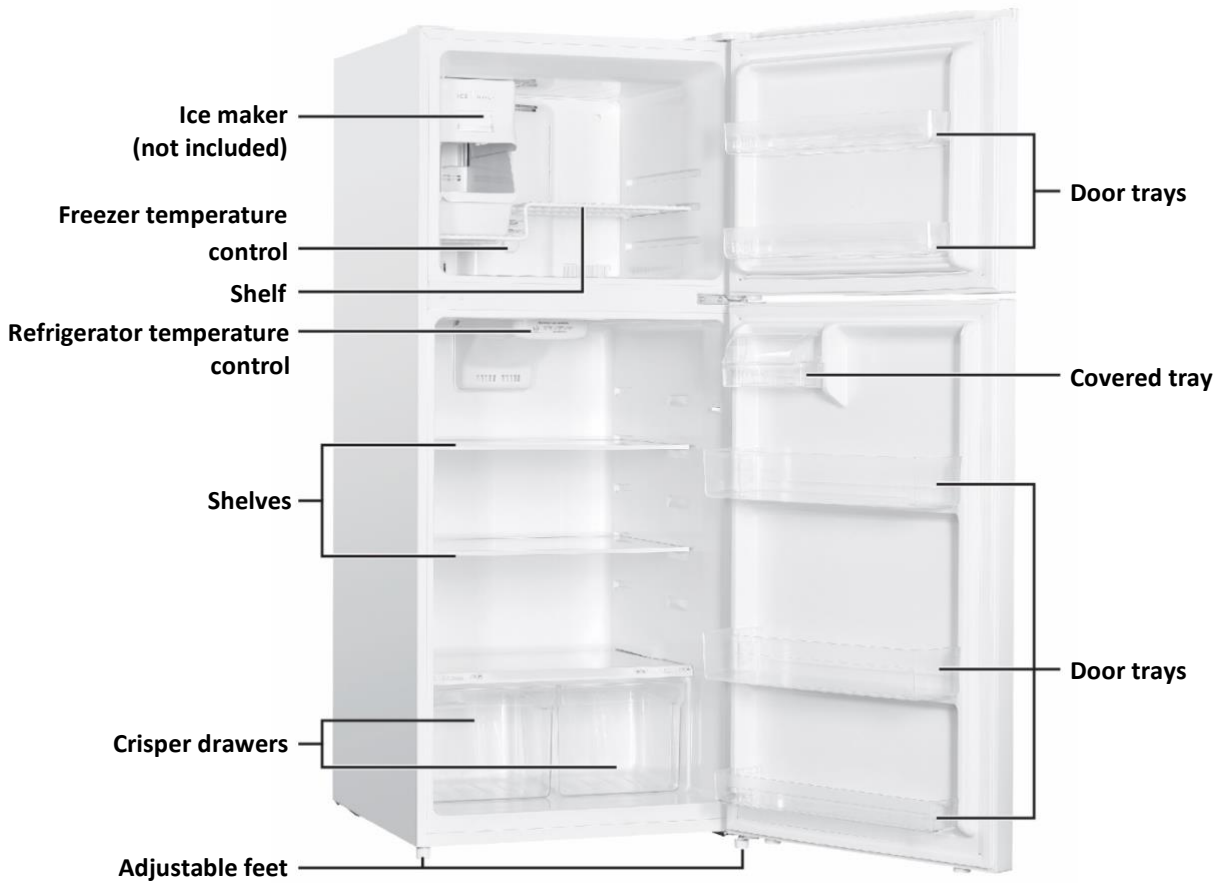

**i** The images in this user manual are only for reference. The actual product may vary slightly. Automatic ice makers are optional accessories (not included) that you can install in most models at any time.

**TEMPERATURE CONTROLS**

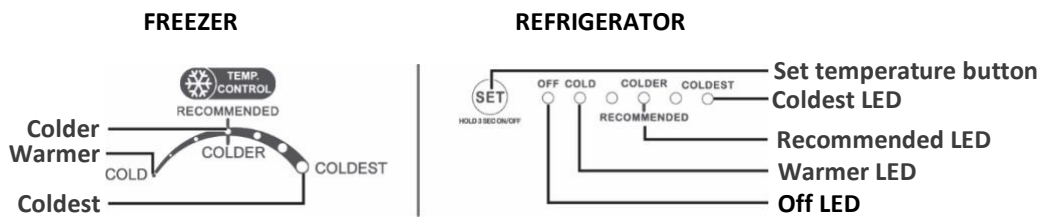

## SETTING UP YOUR REFRIGERATOR

Before using your refrigerator for the first time:

1. Remove all packing materials on the inside and outside of your refrigerator.
2. Reverse your refrigerator doors, if needed. See [“Reversing the doors”](#) on page 5.
3. Position your refrigerator correctly. See [“Positioning your refrigerator”](#) on page 8.
4. Adjust the storage accessories to the layout that best organizes your food. See [“Adjusting storage accessories”](#) on page 9.
5. Clean your refrigerator before its first use. See [“Cleaning and care”](#) on page 13. Make sure that the interior is dry before use.
6. Start up your refrigerator. See [“Turning on your refrigerator”](#) on page 10.

### REVERSING THE DOORS

Your refrigerator arrives with the doors opening from the left side. You can reverse the doors to better accommodate your room’s layout.

**i** Before you start:

- Make sure that your refrigerator is unplugged and empty.
- Make sure that you save all hardware that you remove from your refrigerator so that you can reuse them when reinstalling the doors.
- We recommend having someone help you move your refrigerator and lift the doors.

#### PARTS YOU’LL NEED:



Left hinge



Left hinge cover



Left middle stoppers (x2)



Left middle stopper metal block (x2)

#### TOOLS YOU’LL NEED:



Wrench



Hex driver



Flathead screwdriver



Phillips screwdriver

1. Turn off your refrigerator, and remove all items from the door trays.
2. Remove the top hinge assembly:
  - A. Remove the screws securing the top hinge cover and hole cover with a Phillips screwdriver.

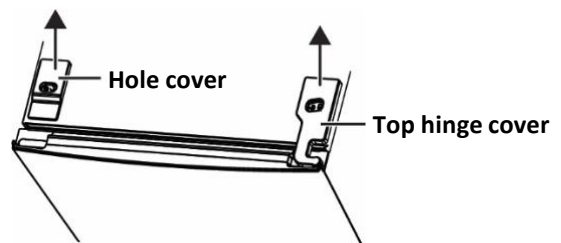

- B. Remove the screws securing the top hinge with a Phillips screwdriver.

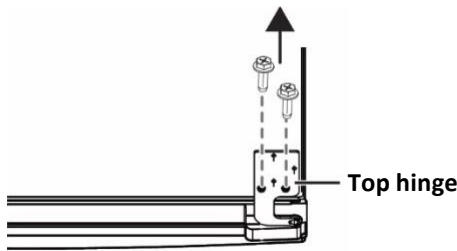

3. Carefully lift off the freezer door.  
4. Remove the screws securing the middle hinge with a Phillips screwdriver.

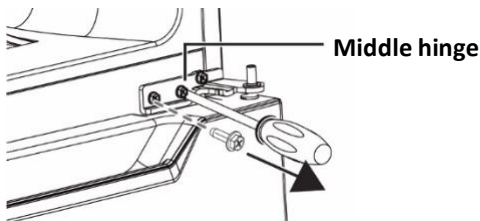

5. Carefully lift off the refrigerator door.  
6. Move the screw hole covers to the other side of your refrigerator.



7. Have someone help you lay down your refrigerator.  
8. Remove your refrigerator's front feet with a hex driver, then remove the lower hinge with a Phillips screwdriver.

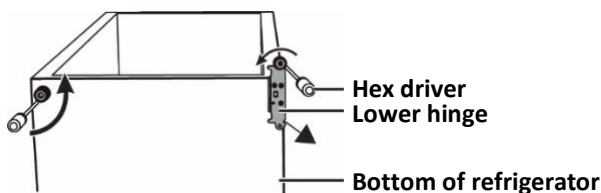

9. Reassemble the bottom hinge:

- A. Remove the bottom hinge pin from the lower hinge with a wrench.

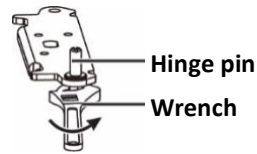

- B. Turn the bottom hinge over.

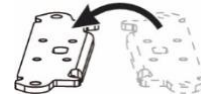

- C. Reinstall the bottom hinge pin onto the other side of the lower hinge.



10. Reinstall the lower hinge on the opposite side of your refrigerator with a Phillips screwdriver, then reinstall the front feet with a hex driver.

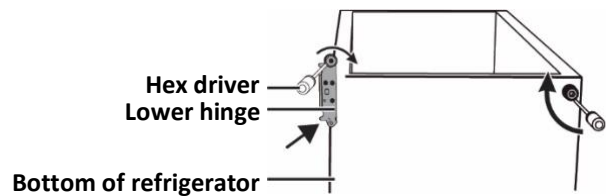

11. Have someone help you lift your refrigerator upright, then place your refrigerator door on the lower hinge.  
12. Remove the middle stopper and metal block on the bottom of the freezer door with a Phillips screwdriver. Save these parts in case you need to reverse your refrigerator door again.

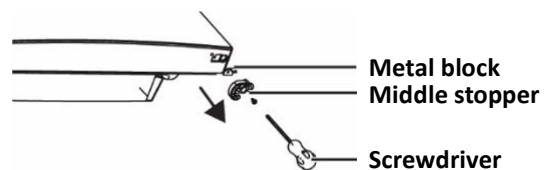

13. Install the middle stopper and metal block from your spare parts bag on the opposite side of the freezer door.

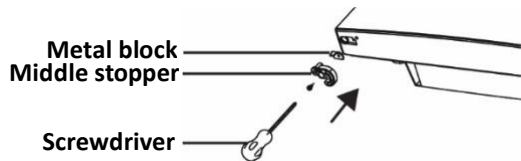

14. Align the middle hinge, making sure that the pin is in the hole on your refrigerator door, then secure in place with screws and a Phillips screwdriver.

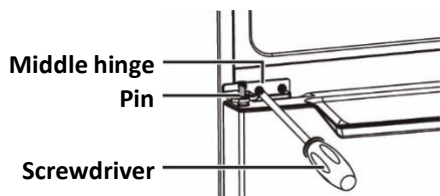

15. Place the freezer door on the middle hinge.
16. Reconnect the top hinge assembly:
  - A. Align the top hinge with the freezer cabinet and door, then secure with screws and a Phillips screwdriver.

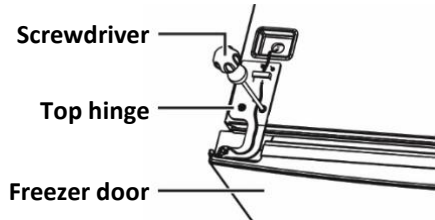

- B. Install the top hinge cover from your spare parts bag with screws and a Phillips screwdriver, then reinstall the hole cover you removed previously on the other side.

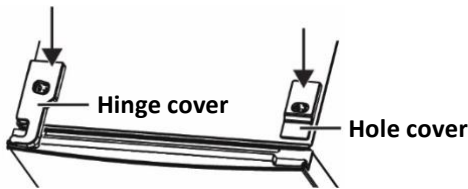

17. Wait two hours before turning on the refrigerator. This reduces the chance of a malfunction in the cooling system from handling or transport.

## POSITIONING YOUR REFRIGERATOR

- Place your refrigerator in a location that lets the doors open fully and allows for air circulation.
  - The refrigerator is 66.9 in. (170 cm) high, 27.9 in. (70.8 cm) wide, and 30.8 in. (78.3 cm) deep.

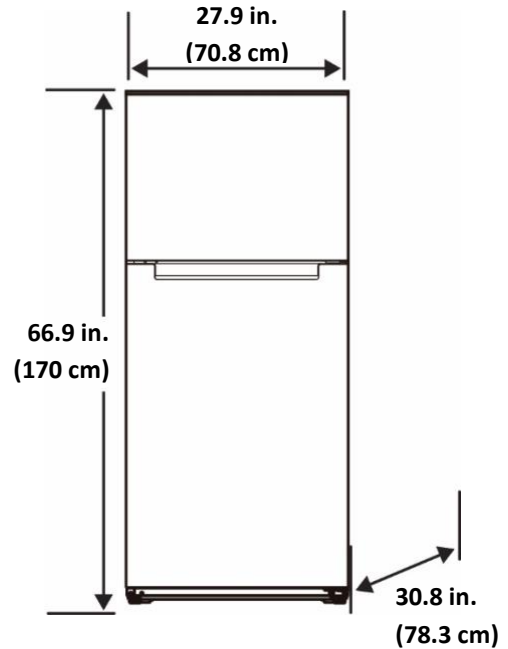

- The doors open at a 135° angle and need 29.3 in. (74.6 cm) in front to open fully.

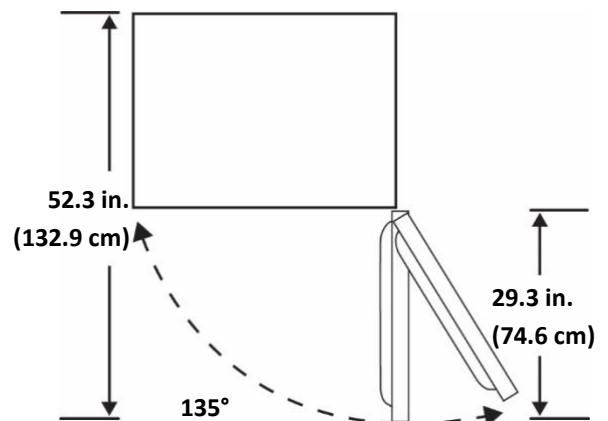



- You must have no less than 2 in. (5 cm) of space to the sides, above, and behind the refrigerator.

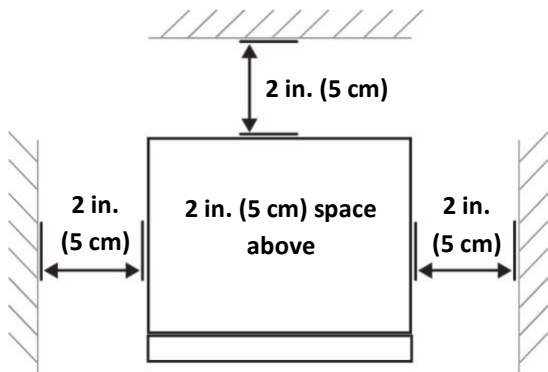

- **Do not place near heat, direct sunlight, or locations where the temperature will rise above 110°F (43°C).** Cookers, radiators, out-buildings, or direct sunlight may increase energy use or affect the acrylic coating. In high ambient temperatures, the compressor will not be able to maintain proper temperature inside the refrigerator.
- **Do not place in a location where the temperature will drop below 50°F (10°C).** The compressor may not be able to maintain proper temperature inside the refrigerator.
- **Do not place the refrigerator in moist or watery places.** Do not put your refrigerator in moist places easy to be splashed with water.

- **Place your refrigerator on a hard, level surface.**
  - To level your refrigerator, turn its front feet to raise (clockwise) or lower (counter-clockwise) them.

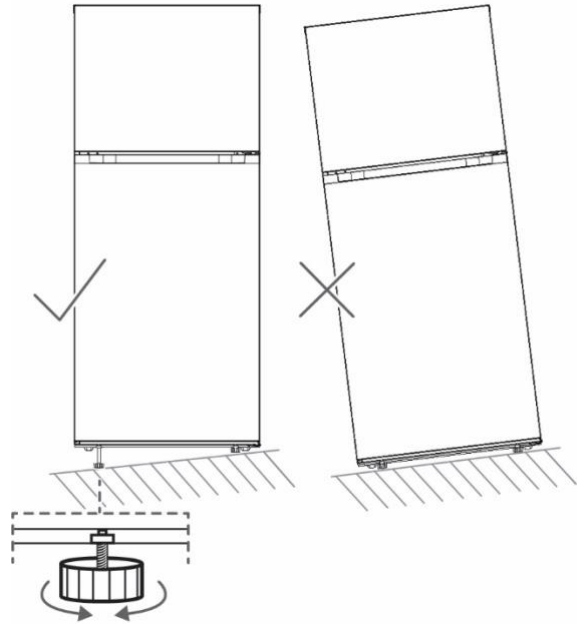

- If your refrigerator is not level, the door may not close properly.
- **Your refrigerator is designed only for household use and similar applications.**
  - Staff kitchen areas in shops, offices, and other working environments
  - Farm houses and by clients in hotels, motels, and other residential-type environments;
  - Bed-and-breakfast-type environments
  - Catering and similar non-retail applications
- **Place your refrigerator in a well-ventilated room.**

## ADJUSTING STORAGE ACCESSORIES

To adjust a shelf's height, pull it forward until it can be swiveled up or down and removed, then slide it back into the guides.

## TURNING ON YOUR REFRIGERATOR



### WARNING: Electrical Connections

- This appliance should be properly grounded for your safety.
- This refrigerator's power cord is equipped with a three-prong plug which connects to standard three-prong wall outlets to minimize the possibility of electrical shock.
- Do not under any circumstances cut or remove the third ground prong from the power cord supplied.
- This refrigerator requires a standard 115/120V AC 60 Hz electrical grounded outlet with three prongs. Have the wall outlet and circuit checked by a qualified electrician to make sure that the outlet is properly grounded.
- When a standard 2-prong wall outlet is encountered, it is your responsibility and obligation to have it replaced with a properly grounded 3-prong wall outlet.
- The cord should be secured behind the appliance and not left exposed or dangling to prevent accidental injury.
- The appliance should always be plugged into its own individual electrical outlet which has a voltage rating that matches the rating label on the appliance. This provides the best performance and also prevents overloading house wiring circuits that could cause a fire hazard from overheating.
- Never unplug the appliance by pulling the power cord. Always grip the plug firmly and pull straight out from the receptacle.
- Immediately repair or replace all power cords that are frayed or otherwise damaged. Do not use a cord that shows cracks or abrasion damage along its length or at either end. When moving the appliance, be careful not to damage the power cord.



### WARNING: Extension Cords

- Because of potential safety hazards under certain conditions, it is strongly recommended that you do not use an extension cord with this appliance.
- If an extension cord is needed, you must use a UL/CUL-listed, 3-wire grounding type appliance extension cord that has a grounding-type plug and outlet and that the electrical rating of the cord be 115 volts and at least 10 amperes.



### WARNING: Surge Protectors

- Most electrical appliances use a series of electric control boards to operate. These boards are very susceptible to power surges and could be damaged or destroyed.
- If your refrigerator is going to be used in an area prone to power surges/outages, it is suggested that you use a power surge protector for all electrical devices/appliances that you use. The surge protector that you select must have a surge block high enough to protect the appliance it is connected to. If you have any questions regarding the type and size of surge protector needed, contact a licensed electrician in your area.
- Damages due to power surges are not considered a manufacturer covered defect and will void your product warranty.

1. After moving your refrigerator or reversing the doors, wait two hours before turning it on. This reduces the chance of a malfunction in the cooling system from handling and transportation.
2. Plug your refrigerator's power cord into a grounded power outlet. Your refrigerator automatically turns on.
3. Set the refrigerator and freezer temperatures to **RECOMMENDED**. See "[Adjusting the temperature](#)" on page [11](#) for more detailed instructions.
4. Let your refrigerator run for at least four hours. When your refrigerator has fully chilled, place your food in your refrigerator and freezer compartments.

## USING YOUR REFRIGERATOR

### ADJUSTING THE TEMPERATURE

Temperatures can vary depending on ambient temperature, frequency of door opening, and how much food is in each compartment. We recommend that you check the temperature with a thermometer to make sure that each compartment is at the desired temperature. The refrigerator temperature ranges from 32°F to 50°F (0°C to 10°C), and the freezer temperature ranges from -10°F to 10°F (-23.3°C to -12.2°C). Adjust the temperature gradually to let the temperature stabilize.

#### REFRIGERATOR TEMPERATURE CONTROL

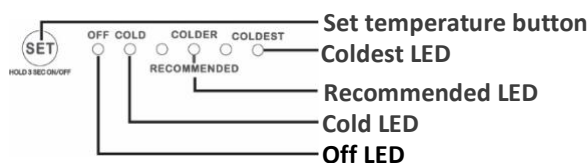

- Press **SET** repeatedly to cycle between the refrigerator temperature settings. The temperature LEDs light up:
  - **COLD**: Warmest temperature
  - **COLDER/RECOMMENDED**: Recommended, moderate temperature (factory default)
  - **COLDEST**: Coldest temperature
- To turn the refrigerator and freezer off or on, press and hold **SET** for three seconds.

**i** After the refrigerator has been turned off, unplugged, or lost power, wait 3–5 minutes before turning the refrigerator back on. If you try to turn it on before this time, the refrigerator will not start.

#### FREEZER TEMPERATURE CONTROL

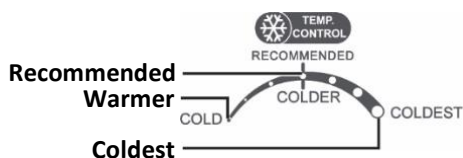

- Turn the freezer control knob to adjust the freezer temperature:
  - **COLD**: Warmest temperature
  - **COLDER/RECOMMENDED**: Recommended, moderate temperature (factory default)

- **COLDEST**: Coldest temperature
- To turn the refrigerator and freezer off or on, press and hold **SET** on the refrigerator temperature control for three seconds.

### STORING FOOD

When storing food in either your refrigerator or freezer compartment:

- Let hot foods cool to room temperature before storing. This helps prevent the internal temperature from rising, which can result in excess electricity use and frost formation.
- Do not overcrowd food. Instead, leave space between items for air circulation so they can be cooled effectively.
- To prevent cross-contamination, flavor transfer, and moisture loss, food should be separately packed or covered and placed on separate shelves. Fruit and vegetables do not need to be wrapped.
- To prevent cold air from escaping, try to limit the number of times you open the doors. When returning from shopping, sort foods to be kept in your refrigerator or freezer before opening the door. Only open the door to put food in or take it out.
- Do not keep food past the manufacturer’s recommended expiration or best by date.

### REFRIGERATING FOOD

When placing food in your refrigerator:

- Keep raw meats on a plate that is large enough to collect juices and cover it with cling film or foil.
- Store cooked meats on a shelf above raw meats to avoid bacterial transfer.
- To maintain freshness, place fruits and vegetables in the crisper drawers to prevent excessive water evaporation. Fruit and vegetables do not need to be wrapped.

**i** Some fresh fruits and vegetables are sensitive to the cold and are not suitable for storage in the crisper drawers.

## FREEZING FOOD

When placing food in your freezer:

- Make sure that you select the correct storage containers or bags:
  - Do not use glass, thin cling film, or used food containers.
  - Use special freezer bags, freezer film, plastic bags, plastic containers, or aluminum foil to store acidic foods (such as citrus fruits).
  - Consider how you want to cook your food before freezing it. Don't freeze food in metal containers if you want to microwave it straight from the freezer.
- Remove as much air from the container or bag as possible. If you're freezing liquids, leave a small amount of air space to allow for expansion.

**i** If you want, you can buy a vacuum pump that sucks extra air out of packaging.

- Chill food in your refrigerator before freezing, if possible.
- Do not place unfrozen food in direct contact with food that is already stored and frozen. Do not add too many unfrozen items at once.
- You can use the space in the freezer most efficiently if you freeze liquids (or solids with liquids, such as stew) in square blocks. Pour the liquid into a plastic bag that is placed inside a square-sided container. Freeze it, then remove the bag from the container and seal the bag.
- Do not store carbonated drinks in the freezer compartment.
- Place frozen food into the freezer as quickly as possible after purchase. If there are instructions on the packet, carefully follow these instructions regarding storage times.
- If you place too much food in the freezer at once, the freezing ability is reduced which affects the quality of your frozen foods.

- If the internal temperature of frozen food rises during maintenance or cleaning, it may shorten the storage life of your food.

## NAVIGATING POWER OUTAGES

If you lose power or your refrigerator stops working:

- After the refrigerator has been turned off, unplugged, or lost power, wait 3–5 minutes before turning the refrigerator back on. If you try to turn it on before this time, the refrigerator will not start.
- Keep the doors closed as much as possible. Even in the summer, foods inside your refrigerator can be kept for several hours.
- Do not place additional food in your refrigerator.
- Place a water-tight container of ice in the freezer to help keep your food cold.
- If a power outage is planned, lower your refrigerator and freezer temperatures as much as possible an hour before the power will go out. Do not store new food during this time.

## SAVING ENERGY

Follow these energy tips to help reduce your refrigerator's energy use:

- Install your refrigerator in the coolest part of the room, out of direct sunlight and away from heating ducts or registers. Do not place your refrigerator next to heat-producing appliances such as a range, oven, or dishwasher.
- Your refrigerator door should remain open only as long as necessary. Organize and label food to reduce door openings. Remove as many items as needed at one time and close the door as soon as possible.
- Do not place hot food inside your refrigerator. Instead, cool food to room temperature before storing.
- Make sure that your refrigerator door is properly closed to avoid increased energy consumption, and the formation of excess ice or condensation inside.
- Constantly circulating cold air keeps the temperature homogenous inside your refrigerator. For this reason, it

is important to properly distribute the food and not block air vents to facilitate the flow of air.

- Cover foods and wipe containers dry before placing them in your refrigerator. This cuts down on moisture buildup inside your refrigerator.

- Do not line the shelves with aluminum foil, wax paper, or paper towels. Liners interfere with cold air circulation, making your refrigerator less efficient, which could cause food spoilage.

## *MAINTAINING YOUR REFRIGERATOR*

### **CLEANING AND CARE**

- Your refrigerator has a frost-free design that doesn't require manual defrosting.
- Before cleaning the interior, turn off the power and remove all foods, drinks, shelves, and drawers.
  - Clean your refrigerator with non-corrosive neutral detergents and a soft cloth or sponge dipped in water. Open the door to air dry before the power is turned on.
  - Clean the freezer with clean water and a dry cloth. Open the door to air dry before the power is turned on.
  - Clean trays, shelves, and drawers with non-corrosive neutral detergents and a soft cloth. Dry them with a soft cloth or let them air dry.
- Wipe the outside cabinet with soapy water or detergent and a soft cloth, then wipe dry.
- Check door seals regularly to make sure that they are clean and free from food particles. Clean with soapy water or diluted detergent and a soft cloth.
- Clean dust and debris behind your refrigerator and on the ground to improve the cooling and energy savings.
- Do not use hard brushes, steel wool, wire brushes, abrasives (such as toothpaste), organic solvents (such as alcohol, acetone, or banana oil), boiling water, acid, or alkaline items to clean refrigerator. These things may damage your refrigerator surface and interior.
- Do not rinse directly with water or other liquids during cleaning to avoid short circuits or damage to electrical insulation.

### **REPLACING THE LIGHT**

Your refrigerator's LED is designed for a long life and is not user replaceable. Contact a qualified service provider to replace.

### **MOVING YOUR REFRIGERATOR**

- Before your refrigerator is moved:
  - Take all objects out of your refrigerator.
  - Secure the shelves, drawers, and doors with tape.
  - Tighten the leveling feet.
- After moving or reversing the door, wait two hours before turning on your refrigerator. This reduces the chance of a malfunction in the cooling system from handling and transportation.

## PREPARING FOR LONG-TERM STORAGE

If your refrigerator is not going to be used for several months, turn it off, unplug it, remove all food, clean/dry it, and leave the doors open (or remove them) to prevent unpleasant smells or mold.

 **WARNING:** Supervise small children to make sure that they do not climb inside the refrigerator.

## SAFETY AND PRECAUTIONS

We have provided many important safety messages in this manual for your appliance. Always read and obey all safety messages.

 <b>WARNING</b>	<p>This is the Safety Alert Symbol. This symbol alerts you to potential hazards that can kill or injure you and others. All safety messages will follow the Safety Alert Symbol and either the words “DANGER,” “WARNING,” or “CAUTION.”</p>
---	---

 <b>DANGER</b>	<p>Danger means that failure to heed this safety statement may result in severe personal injury or death.</p>
--	---

 <b>WARNING</b>	<p>Warning means that failure to heed this safety statement may result in extensive product damage, serious personal injury, or death.</p>
---	--

<b>CAUTION</b>	<p>Caution means that failure to heed this safety statement may result in minor or moderate personal injury, property, or equipment damage.</p>
----------------	---

All safety messages will alert you to know what potential hazard is, tell you how to reduce the chance of injury, and let you know what can happen if the instructions are not followed.

### REFRIGERANT GAS WARNINGS

 **CAUTION:** Risk of Fire

## SERVICING YOUR REFRIGERATOR

Your refrigerator should be serviced by a qualified technician, and only genuine spare parts should be used. Under no circumstances should you attempt to repair the refrigerator yourself. Repairs carried out by inexperienced persons may cause injury or serious malfunction. Contact a qualified technician.

- **DANGER:** Risk of fire or explosion. Flammable refrigerant used.
- **DO NOT** use mechanical devices to defrost the refrigerator. **DO NOT** puncture refrigerant tubing.
- **DANGER:** Risk of fire or explosion. Flammable refrigerant used. To be repaired only by trained service personnel. **DO NOT** puncture refrigerant tubing.
- **CAUTION:** Risk of fire or explosion. Flammable refrigerant used. Consult repair manual/owner’s guide before attempting to service this product. All safety precautions must be followed.
- **CAUTION:** Risk of fire or explosion. Dispose of property in accordance with federal or local regulations. Flammable refrigerant used.
- **CAUTION:** Risk of fire or explosion due to puncture of refrigerant tubing. Follow handling instructions carefully. Flammable refrigerant used.
- **CAUTION:** This appliance is not intended for use by persons (including children) with reduced physical, sensory, or mental capabilities, or lack of experience and knowledge, unless they have been given supervision or instruction concerning use of the appliance by a person responsible for their safety. Children should be supervised to ensure that they do not play with the appliance.

### IMPORTANT SAFEGUARDS

 Before the refrigerator is used, it must be properly positioned and installed as described in this manual, so read the manual carefully. To reduce the risk of fire, electrical shock, or injury when using the refrigerator, follow basic precautions, including the following:

** DANGER**

- Plug into a grounded 3-prong outlet, do not remove the grounding prong, do not use an adapter, and do not use an extension cord.
- It is recommended that a separate circuit, serving only your refrigerator be provided. Use receptacles that cannot be turned off by a switch or pull chain.
- Never clean refrigerator parts with flammable fluids. These fumes can create a fire hazard or explosion. Do not store or use gasoline or other flammable vapors and liquids in the vicinity of this or any other appliance. The fumes can create a fire hazard or explosion.
- Before proceeding with cleaning and maintenance operations, make sure that the refrigerator's power cord is disconnected.
- Do not connect or disconnect the electric plug when your hands are wet.
- If the SUPPLY CORD is damaged, it must be replaced by the manufacturer, its service agent or similarly qualified persons in order to avoid a hazard.
- Unplug the refrigerator or disconnect power before cleaning or servicing. Failure to do so can result in electrical shock or death.
- Do not attempt to repair or replace any part of your refrigerator unless it is specifically recommended in this manual. All other servicing should be referred to a qualified technician.

** WARNING****FOLLOW WARNINGS BELOW ONLY WHEN APPLICABLE TO YOUR MODEL:**

- Use two or more people to move and install your refrigerator. Failure to do so can result in back or other injury.
- To ensure proper ventilation for your refrigerator, the front of the unit must be completely unobstructed. Choose a well-ventilated area with temperatures above 60°F (16°C) and below 90°F (32°C). This refrigerator must be installed in an area protected from the elements, such as wind, rain, water spray, or drips.
- The refrigerator should not be located next to ovens, grills, or other sources of high heat.
- The refrigerator must be installed with all electrical, water, and drain connections in accordance with state and local codes. A standard electrical supply (115 V AC only, 60 Hz), properly grounded in accordance with the National Electrical Code and local codes and ordinances is required.
- Do not kink or pinch the power supply cord of your refrigerator.
- The fuse (or circuit breaker) size should be 15 amperes.
- It is important for the refrigerator to be leveled in order to work properly. You may need to make several adjustments to level it.
- All installation must be in accordance with local plumbing code requirements.
- Make sure that the pipes are not pinched, kinked, or damaged during installation.
- Check for leaks after connection.
- Never allow children to operate, play with, or crawl inside the refrigerator.
- If you use the drainage container, you must unplug the refrigerator or the water can overflow from the drainage container.
- Although the unit has been tested at the factory, due to long-term transit and storage, the first batch of ice cubes must be discarded.
- Do not use solvent-based cleaning agents or abrasives on the interior. These cleaners may damage or discolor the interior.
- Do not use this refrigerator for anything other than its intended purpose.
- Do not use electrical appliances inside the food storage compartments of the appliance, unless they are of the type recommended by the manufacturer.



**Prop. 65 Warning for California Residents**

**WARNING:** Cancer and Reproductive Harm - [www.P65Warnings.ca.gov](http://www.P65Warnings.ca.gov).

## IMPORTANT SAFETY INSTRUCTIONS

### **WARNING**

To reduce the risk of fire, electrical shock, or injury when using your refrigerator-freezer, follow these basic precautions:

- Read all instructions before using the refrigerator.
- **DANGER or WARNING:** Risk of child entrapment. Child entrapment and suffocation are not problems of the past. Junked or abandoned refrigerators are still dangerous, even if they will “just sit in the garage a few days.”

## SPECIFICATIONS

- **Dimensions** (H × W × D): 66.9 × 27.9 × 30.8 in. (170 × 70.8 × 78.3 cm)
- **Net weight:** 158.7 lbs. (70 kg)
- **Gross weight:** 176.4 lbs. (77 kg)
- **Capacity:** 17.6 ft.<sup>3</sup> (.5 m<sup>3</sup>)
- **Rated voltage:** 115 V
- **Rated frequency:** 60 Hz

- Before you throw away your old refrigerator: Take off the doors. Leave the shelves in place so that children may not easily climb inside.
- Never allow children to operate, play with, or crawl inside the refrigerator.
- Never clean refrigerator parts with flammable fluids. The fumes can create a fire hazard or explosion.
- Do not store or use gasoline or any other flammable vapors and liquids in the vicinity of this or any other refrigerator. The fumes can create a fire hazard or explosion.

## SAVE THESE INSTRUCTIONS

THIS APPLIANCE IS FOR HOUSEHOLD USE ONLY



## TROUBLESHOOTING

If your refrigerator has problems, check this table before making a service call.

PROBLEM	SOLUTION
Not turning on	<ul style="list-style-type: none"> <li>• Make sure that your refrigerator is securely connected to a working power outlet.</li> <li>• Check if the power is out or a circuit breaker has tripped.</li> <li>• Make sure that the power outlet uses the correct voltage (115 V).</li> </ul>
Bad odor	<ul style="list-style-type: none"> <li>• Make sure that foods are tightly wrapped.</li> <li>• Make sure that there is no rotten food in your refrigerator.</li> <li>• Clean the inside of your refrigerator.</li> </ul>
Compressor runs for a long time or turns on and off frequently	<ul style="list-style-type: none"> <li>• The compressor running for a long time is normal in the summer when the ambient temperature is high.</li> <li>• Make sure that your refrigerator is not overloaded with too much food. Keep items separated to promote better air circulation.</li> <li>• Make sure that your refrigerator has the correct clearances for air circulation. See "<a href="#">Positioning your refrigerator</a>" on page 8 for more information.</li> <li>• Cool foods to room temperature before placing them inside your refrigerator.</li> <li>• The doors are opened too frequently. Keep the doors closed.</li> <li>• Adjust your refrigerator or freezer compartment's temperature.</li> <li>• Clean the door seals and check them for damage.</li> </ul>
Light is not working	<ul style="list-style-type: none"> <li>• Make sure that your refrigerator is turned on and running.</li> <li>• If the light is burned out or damaged, have it replaced by a qualified service provider.</li> </ul>
Doors are not properly closing	<ul style="list-style-type: none"> <li>• Move items that are preventing the door from closing.</li> <li>• Make sure that your refrigerator is on a hard, flat surface and adjust the leveling feet.</li> <li>• Clean the door seals and check them for damage.</li> </ul>
Loud noise	<ul style="list-style-type: none"> <li>• Make sure that the floor and refrigerator are level and stable.</li> <li>• Make sure that accessories are placed in their proper locations.</li> </ul>
Door seal is not tight	<ul style="list-style-type: none"> <li>• Clean the door seals.</li> <li>• Heat the door seal (blow it with a hair dryer or use a hot towel) and then cool it to restore the seal.</li> </ul>

PROBLEM	SOLUTION
Water pan overflows	<ul style="list-style-type: none"> <li>• There is too much food in the chamber or food stored contains too much water, causing heavy defrosting. Remove excess food.</li> <li>• The doors are not closed properly, causing increased water from defrosting. Move items blocking the door or check the door seal.</li> </ul>
Hot housing	<ul style="list-style-type: none"> <li>• It is normal to have heat from the built-in condenser dissipate through the housing. If the housing becomes too hot due to high ambient temperature, storage of too much food, or compressor shutdown, make sure that you have good ventilation to help with heat dissipation.</li> </ul>
Surface condensation	<ul style="list-style-type: none"> <li>• Condensation on the outside of your refrigerator and door seals is normal when the ambient humidity is too high. Just wipe the condensate with a clean towel.</li> </ul>
Abnormal noise	<ul style="list-style-type: none"> <li>• The compressor may produce buzzes during operation, and the buzzes are loud particularly upon start or stop. This is normal.</li> <li>• Refrigerant flowing inside of the appliance may creak, which is normal.</li> <li>• Make sure that your refrigerator is level.</li> </ul>

## CUSTOMER SUPPORT

If you have questions about your refrigerator, our customer support team is ready to help.

- **Online chat:** [www.elementelectronics.com](http://www.elementelectronics.com)
- **Phone:** 1 (833) 250-6588
- **Email:** [appliance@elementelectronics.com](mailto:appliance@elementelectronics.com)

## LEGAL NOTICES

### DISPOSAL

Old units still have some residual value. An environmentally friendly method of disposal will ensure that valuable raw materials can be recovered and used again. The refrigerant used in your unit and insulation materials require special disposal procedures. Ensure that none of the pipes on the back of the unit are damaged prior to disposal. Up to date information concerning options of disposing of your old unit and packaging from the new one can be obtained from your local council office.

When disposing of an old unit break any old locks or latches and remove the door as a safeguard.

### CORRECT DISPOSAL OF THIS PRODUCT

Old appliances still have some residual value. An environmentally friendly method of disposal will ensure that valuable raw materials can be recovered and used again.



This marking indicates that this product should not be disposed with other household wastes

throughout the US. To prevent possible harm to the environment or human health from uncontrolled waste disposal, recycle it responsibly to promote the sustainable reuse of material resources. To return your used device, please use the return and collection systems or contact the retailer where the product was purchased. They can take this product for environmentally safe recycling.

For more information, please contact the local authority or your retailer where you purchased the product.

## WARRANTY

Model Names/Numbers Subject to Limited Warranty:

17.6 Cu. Ft. Refrigerator  
(ENR18TFGBW / ENR18TFGBB / ENR18TFGBS)

(the “Products” or “Product” when referencing a singular product herein)

This Product (including any accessories included in the original packaging) as supplied and distributed in new condition, is warranted by Element Appliance Company, LLC (“Element”) to the original customer who purchases the Product from an authorized Element retailer (the “Original Customer” or “you”) against defects in material and workmanship under proper use, maintenance, and care according to the owner’s manual, warnings, and instructions accompanying the Product (“Warranty”) as follows:

\* **PLEASE NOTE** – Proof of purchase evidencing the date of purchase by the Original Purchaser from an authorized Element retailer (“Valid Proof of Purchase”) is **required** for all Warranty service. The express Warranty set forth herein is subject to all terms and conditions set forth below.

#### 1. WARRANTY SERVICE:

**A. ONE-YEAR WARRANTY:** Except as provided in subpart 1.B below, for a period of **one (1) year** from

the date of purchase by the Original Customer (the “Warranty Period”), if the parts or components covered by this Warranty are determined by Element or Element’s authorized service provider to be defective in material or workmanship, Element will, at its sole and absolute discretion and option: (i) repair the defective part or component at no charge to the Original Customer, (ii) replace the defective Product with a new Product of similar or better quality, at no charge to the Original Customer, or (iii) refund the documented purchase price paid by the Original Customer (excluding tax) to the Original Customer upon return of the defective Product as directed by Element. After the Warranty Period expires, the Original Customer must pay for all parts, components, shipping and handling, labor, and replacement costs associated with the Product or any part or component thereof, regardless of any defects in the Product or any part or component thereof.

**B. LIMITED EXTENDED WARRANTY THROUGH PRODUCT REGISTRATION:** If and only if the Original Customer registers the Product at <http://www.elementelectronics.com> within **ninety (90) days** of the date of purchase by the Original Customer, then the Warranty Period

discussed in subpart 1.A. above shall be extended an additional one (1) year to a new Warranty Period equaling **two (2) years** from the date of purchase by the Original Customer. If the Product is not registered as provided for in this subpart 1.B, then the standard one-year Warranty Period set forth in subpart 1.A shall apply.

- C. TIMING AND PROCEDURE:** Before Warranty service can commence, the Original Customer must contact either (i) the retailer from whom the Original Customer purchased the Product, or (ii) Element directly, in either case for problem determination and service procedures. Valid Proof of Purchase evidencing that the Product is within the Warranty Period **MUST** be presented by Original Customer in order to obtain the requested Warranty service. Please have your model and serial number available, along with your date of purchase of the Product. To remain eligible for Warranty service, Original Customer may not return the Product or any part or component thereof to the retailer or Element without Element's prior written consent.

## **2. EXCLUSIONS AND LIMITATIONS TO WARRANTY SERVICE**

The Warranty covers manufacturing defects in materials and workmanship of the Product encountered in the normal, non-commercial use of the Product, and **does not cover** (a) damages or malfunctions resulting from improper or unreasonable use or maintenance, abuse, negligence, failure to follow instructions contained in any written materials that accompany the Product, deterioration by reason of excess moisture, corrosive atmosphere, lightning, power surges, connections to improper voltage supply, unauthorized alteration, or other external causes such as extremes in temperature or humidity, modifications, scratches or discoloration; (b) improper or incorrectly performed repairs by service providers not authorized by Element; (c) transportation, shipping, delivery, pickup, insurance, installation, or set-up costs; (d) ordinary wear and tear, cosmetic damage, or damage due to acts of nature, including but not limited to, water, floods, wind, storm, tornado, earthquake, or fire, or due to damage caused by extraordinary impact events, such as dropping, crushing, demolition or other extraordinary damage; (e) commercial use of the Product, or use of the Product for anything other than single-family household or

residential use; or (f) modification of the Product or any part of the Product.

This Warranty is made to the Original Customer only and does not cover Products sold AS IS or WITH ALL FAULTS. The Warranty is invalid if the factory-applied serial number has been altered or removed from the Product. This Warranty is valid only in the United States, and only applies to Product if it was purchased and serviced in the United States. The addition of equipment or features to the Product that are not manufactured or recommended by Element could affect the intended function of the Product, and therefore may void the Warranty. Furthermore, the exposure of the Product to chemicals, heat, cold, humidity, or other elements can affect the Product components, and therefore, the Warranty does not cover discoloration, fading, cosmetic changes, rust, or any damages or failure related to any such items. The Warranty is contingent upon the proper use, maintenance, and care of the Product. The Warranty may be void if the Product has been used in a manner contradictory to, or in violation of, the terms of the user's manual, warnings, or instructions accompanying the Product.

**THIS WARRANTY IS MADE IN LIEU OF AND SUPERSEDES ALL OTHER WARRANTIES OR CONDITIONS OF MERCHANTABILITY OR FITNESS FOR A PARTICULAR PURPOSE OR GENERAL USE, WHETHER EXPRESS, IMPLIED, COLLATERAL, STATUTORY, OR PROVIDED BY COMMON LAW, THE UNIFORM COMMERCIAL CODE, OR OTHERWISE. ELEMENT FURTHER DISCLAIMS ALL WARRANTIES AFTER THE END OF THE WARRANTY TERM DEFINED ABOVE. NO OTHER EXPRESS WARRANTY OR GUARANTY GIVEN BY ANY OTHER PERSON, FIRM, OR ENTITY WITH RESPECT TO THE PRODUCT SHALL BE BINDING ON ELEMENT. REPAIR, REPLACEMENT, OR REFUND OF THE ORIGINAL PURCHASE PRICE, AT ELEMENT'S SOLE DISCRETION, ARE THE EXCLUSIVE REMEDIES OF THE CUSTOMER.**

**ELEMENT SHALL NOT BE LIABLE FOR ANY INCIDENTAL OR CONSEQUENTIAL DAMAGES CAUSED BY THE USE, MISUSE, OR INABILITY TO USE THE PRODUCT. THESE INCLUDE, BUT ARE NOT**

**LIMITED TO, ANY DAMAGES IN THE FORM OF LOST PROFITS, LOSS OF USE, LEGAL FEES, ECONOMIC LOSS, PERSONAL INJURIES, OR ANY OTHER DAMAGES CAUSED BY CIRCUMSTANCES BEYOND THE CONTROL OF ELEMENT. NOTWITHSTANDING THE FOREGOING, ELEMENT'S AGGREGATE LIABILITY TO ANY CUSTOMER SHALL NOT EXCEED THE ORIGINAL PURCHASE PRICE OF THE PRODUCT. THIS WARRANTY SHALL NOT EXTEND TO ANYONE OTHER THAN THE ORIGINAL CUSTOMER WHO PURCHASED THE PRODUCT, AND IS NOT TRANSFERRABLE. NO PERSON IS AUTHORIZED TO ALTER, EXTEND, OR WAIVE THIS WARRANTY OR ANY OF ITS TERMS OR CONDITIONS.**

Some states do not allow the exclusion or limitation of incidental or consequential damages, or allow limitations on warranties, so the above limitations or exclusions may not apply to you. This Warranty gives you specific rights, and you may have other rights, which vary from state to state. The exclusions and limitations to the Warranty apply to the maximum extent permitted by law and unless restricted or prohibited by law. Where any term of this Warranty is prohibited by applicable law, it shall be null and void, but the remainder of this Warranty shall remain in effect.

**PLEASE DIRECT ALL CORRESPONDENCE TO:**

Element Appliance Company, LLC

[appliance@elementelectronics.com](mailto:appliance@elementelectronics.com)

1 (833) 250-6588

<https://elementelectronics.com/appliances>











**CONTACT US:**

Element Appliance Company, LLC. Customer Service

**ONLINE CHAT:** [www.elementelectronics.com](http://www.elementelectronics.com)

**Customer Support:** 1 (833) 250-6588

[appliance@elementelectronics.com](mailto:appliance@elementelectronics.com)

© 2022 Element Appliance Company, LLC. All rights reserved.

Element Appliance Company and E Element are trademarks of Element Brand Holding, LLC

V2 | 21-1117